

ICC-ES Evaluation Report

ESR-1539

Reissued July 2022

Revised April 2024

Subject to renewal July 2024

This report also contains:

- CBC Supplement
- FBC Supplement
- LABC Supplement

ICC-ES Evaluation Reports are not to be construed as representing aesthetics or any other attributes not specifically addressed, nor are they to be construed as an endorsement of the subject of the report or a recommendation for its use. There is no warranty by ICC Evaluation Service, LLC, express or implied, as to any finding or other matter in this report, or as to any product covered by the report.

Copyright © 2024 ICC Evaluation Service, LLC. All rights reserved.

<p>DIVISION: 06 00 00— WOOD, PLASTICS AND COMPOSITES</p> <p>Section: 06 05 23.13— Nails</p> <p>Section: 06 05 23.15— Staples</p>	<p>REPORT HOLDER: INTERNATIONAL STAPLE, NAIL AND TOOL ASSOCIATION (ISANTA)</p> <p>ADDITIONAL LISTEES: (see below)</p>	<p>EVALUATION SUBJECT: POWER-DRIVEN STAPLES AND NAILS</p>	
<p>AIMS LEADING INDUSTRIAL FACTORY (ALIF)</p> <p>BECK AMERICA, INC.</p> <p>FALCON FASTENERS REG'D</p> <p>GEEKAY WIRES LTD.</p> <p>HUTTIG BUILDING PRODUCTS</p> <p>ILLINOIS TOOL WORKS</p> <p>INMAX GROUP – INMAX SDN. BHD. & INMAX INDUSTRIES SDN. BHD.</p> <p>KOKI HOLDINGS AMERICA LTD.</p> <p>KYOCERA SENCO INDUSTRIAL TOOLS, INC.</p>		<p>MID-CONTINENT STEEL & WIRE (MID-CONTINENT NAIL)</p> <p>NATIONAL NAIL CORP.</p> <p>OMAN FASTENERS, LLC.</p> <p>PEACE INDUSTRIES</p> <p>PRIMESOURCE BUILDING PRODUCTS</p> <p>SHANGHAI YUEDA NAILS CO., LTD. – SHANGHAI YUEDA NAIL CO. LTD. & YF TECHNOLOGY CORPORATION (THAILAND) LTD.</p> <p>SPECIALTY FASTENING SYSTEMS, INC. DBA SPECIALTY NAIL CO.</p> <p>STANLEY BLACK AND DECKER INC.</p>	

1.0 EVALUATION SCOPE

Compliance with the following codes:

- 2021, 2018, 2015 and 2012 [International Building Code® \(IBC\)](#)
- 2021, 2018, 2015 and 2012 [International Residential Code® \(IRC\)](#)

For evaluation for compliance with codes adopted by the [Los Angeles Department of Building and Safety \(LADBS\)](#), see the [ESR-1539 LABC and LARC Supplement](#).

Properties evaluated:

- Bending yield strength
- Compliance with prescriptive requirements of the IBC and IRC.
- Compliance with material requirements, dimensions, and tolerances of ASTM F1667.
- Use in diaphragms, shear walls and braced walls.
- Fastening schedules which are alternates to those included in the codes.

2.0 USES

The nails and staples described in this report are used for engineered and nonengineered (prescriptive) structural connections.

3.0 DESCRIPTION

3.1 General:

The fasteners addressed in this report are manufactured by and for the additional listees on this report, which are member companies of the International Staple, Nail and Tool Association (ISANTA). [Appendix B](#) of this report lists the fasteners evaluated for each listee.

3.2 Staples:

Evaluated staples are manufactured from bright or zinc-coated carbon steel wire. Evaluated staples comply with Table 57 of ASTM F1667-20 and have the characteristics shown in the table below. The staples have a minimum crown width of $\frac{7}{16}$ inch (11.1 mm) and a minimum leg length of $1\frac{1}{2}$ inches (38 mm). The staples are collated into strips and coated with polymer coatings. Staple crown widths and leg lengths specified in this report are overall dimensions.

TABLE 3.2—STAPLE CHARACTERISTICS

STAPLE GAGE	NOMINAL WIRE DIAMETER (inch)	NOMINAL STAPLE WIDTH (inch)	MINIMUM BENDING MOMENT (lbf.-in.)
14	0.080	0.0855	4.3
15	0.0720	0.073	4.0
16	0.0625	0.064	3.6

For SI: 1 inch = 25.4 mm; 1 lbf-in = 0.113 N-m.

3.3 Nails:

Evaluated nails are manufactured from bright steel wire, galvanized steel wire, or stainless steel wire. The nails have full round heads or modified round heads, such as offset heads, clipped heads (“D” heads) and notched heads, as shown in [Figure 1](#). Nails have smooth or deformed (threaded) shanks. Deformed shanks may be annularly threaded (ring shank) or helically threaded (screw shank). Dimensional tolerances conform to ASTM F1667.

Nails designated as Metal Hardware Nails (MHN) are primarily intended for use with metal hardware (e.g. joist hangers, strap anchors, etc.), but may also be used in other engineered and prescriptive wood-to-wood or metal-to-wood connections. They have full round heads and smooth or ring shanks.

Nails with coating designated as EG are electro-galvanized in accordance with ASTM A641, Class 1. Nails with coating designated as MG are coated with mechanically deposited zinc complying with ASTM B695, Class 40. Nails with coating designated as HDG are either formed from hot-dip galvanized wire complying with ASTM A641 Class 3S or are hot-dip galvanized after forming in accordance with ASTM A153, Class D. All galvanized nails addressed in this report comply with the requirements of Section 10.1 of ASTM F1667. Corrosion resistance of other coatings addressed in [Appendix B](#) of this report is outside the scope of this report, but is addressed in other ICC-ES evaluation reports as noted in [Appendix B](#).

Many nail products addressed in this report are coated with proprietary polymer coatings. These coatings are intended to aid in the driving of nails when used with power tools. The effect of these coatings has been considered in the determination of withdrawal design values for smooth shank nails.

Nails are collated and coated into strips or coils for loading into a power driving tool. Typical evaluated products are illustrated in [Figure 1](#). [Table 1](#) lists nail sizes addressed in this report. See [Appendix B](#) for detailed nail descriptions including bending yield strength for products evaluated for each listee. Nails for each listee having the same diameter, shank type and finish type as those listed in [Appendix B](#), are qualified for any length.

3.4 Wood:

Wood members must be as described in the tables in this report. Sawn lumber, glued laminated timber (GL) and cross-laminated timber (CLT) must have an assigned specific gravity (SG) equal to or greater than what is required in the applicable table. Where use of engineered wood products is addressed in tables in this report, the products must have an equivalent specific gravity (ESG) equal to or greater than the SG that is addressed in the table, as shown in the applicable ICC-ES evaluation report for the engineered wood product.

3.5 Steel Side Plates:

Steel side plates must comply with ASTM A653 SS Grade 33 or 40, or with ASTM A36, as indicated in [Table 4](#). The steel must have a minimum base steel thickness as indicated in [Table 4](#). Holes in steel side plates must be predrilled or prepunched to allow for the installation of the nails.

4.0 DESIGN AND INSTALLATION

4.1 Design for Staples:

4.1.1 Engineered Connections: Reference withdrawal design values for staples addressed in this report may be calculated in accordance with Section A2.3 of [Appendix A](#). Reference withdrawal design values for select connections are shown in [Table 5](#). The reference lateral design values for staples addressed in this report may be calculated in accordance with Section A2.2 of [Appendix A](#).

4.1.2 Engineered Diaphragms and Shear Walls: The staples addressed in this report may be used in engineered diaphragms and shear walls, in accordance with the diaphragm and shear wall design tables in the IBC and [Tables 6 through 10](#), when the staples comply with the requirements in the applicable table for gage, crown width and leg length. Diaphragm and shear wall deflection must be determined in accordance with Section A3.2.

4.1.3 Prescriptive Sheathing Attachments: The staples addressed in this report may be used to attach sheathing to wood framing as prescribed in the code tables referenced in [Table 2](#), when the staples comply with the code requirements for gage, crown width and leg length.

4.2 Design for Nails:

4.2.1 Engineered Connections: All reference design values must be multiplied by all applicable adjustment factors in accordance with the ANSI/AWC National Design Specification for Wood Construction (NDS).

4.2.1.1 Reference Lateral Design Values: The nails addressed in this report comply with the requirements of IBC Section 2303.6 and may be used in lateral connections designed in accordance with the NDS, using the specified minimum bending yield strength and the nominal diameter shown in [Appendix B](#), as applicable. The yield mode equations in the NDS for nails are shown in Section A1.2 of [Appendix A](#) to this report. Reference lateral design values for common wood-to-wood connections are shown in [Table 3](#), and reference lateral design values for common metal-side-plate-to-wood connections are shown in [Table 4](#).

4.2.1.2 Reference Withdrawal Design Values: The nails addressed in this report may be used in tension connections designed in accordance with the NDS, using the nominal diameter shown in [Appendix B](#), as applicable, and the embedded length of the nail in the holding member. For stainless steel nails, the reference withdrawal design values must be determined in accordance with the 2018 NDS, for use under the 2021, 2018, 2015 and 2012 IBC. Reference withdrawal design values for common wood specific gravities are shown in [Table 5](#). The withdrawal equations in the 2018 NDS for nails are shown in Section A1.3 of [Appendix A](#) to this report.

4.2.1.3 Reference Head Pull-through Design Values: For nails shown in [Appendix B](#) as having round heads, reference head pull-through values must be determined in accordance with Section 12.2.5 of the 2018 NDS, for use under the 2021, 2018, 2015 and 2012 IBC. For nails shown in [Appendix B](#) as having other head styles, determination of reference head pull-through design values is outside the scope of this report.

4.2.2 Prescriptive Framing Connections: The carbon steel nails may be used for prescriptive framing connections when the nails comply with the requirements in the applicable code for diameter and length. In addition, [Tables 11, 12 and 13](#) show fastening designs for framing connections under the 2021, 2018, 2015 and 2012 IBC and IRC, which are alternatives to what is prescribed in 2021 IBC Table 2304.10.2 (2018 and 2015 IBC Table 2304.10.1, 2012 IBC Table 2304.9.1) and in IRC Table R602.3(1). These alternative fastener designs address the use of carbon steel nails only. The alternative fastener designs shown in [Tables 11, 12 and 13](#) are summarized in [Table 14](#).

4.2.3 Prescriptive Metal Hardware Connections: Nails designated as Metal Hardware Nails, as well as other nails described in this report as having full round heads and the applicable dimensions, may be used to attach metal hardware (e.g. joist hangers, foundation anchors) to wood framing members as prescribed in ICC-ES evaluation reports on metal hardware. Use of Metal Hardware Nails in diaphragms and shear walls is outside the scope of this report.

4.2.4 Engineered Diaphragms and Shear Walls: The nails may be used in shear walls and diaphragms designed in accordance with the ANSI/AWC Special Design Provisions for Wind and Seismic (SDPWS) and the tables in this report when they are of the required material, shank type, diameter and length indicated in [Tables 6](#) through [9](#) of this report, and when indicated in [Appendix B](#) as meeting the head area requirements for use in lateral force resisting assemblies for the applicable nail size.

Allowable shear values for diaphragms comprised of wood structural panels attached to wood framing are shown in [Tables 6](#) and [7](#). Design of roof diaphragms must consider uplift due to wind.

Allowable shear values for shear walls comprised of wood structural panels attached directly to wood framing or over gypsum sheathing are shown in [Tables 8](#) and [9](#). Design of exterior shear walls must also consider transverse (out-of-plane) loads on sheathing due to wind.

Allowable shear values for shear walls comprised of fiberboard sheathing, gypsum lath and plaster, gypsum sheathing, gypsum wallboard, metal or wire lath and plaster, or plywood siding applied directly to wood framing are shown in [Table 10](#).

To determine design shear values for use in LRFD, allowable shear values for shear walls and diaphragms resisting seismic loads must be multiplied by 1.4 (1.6 for the 2018, 2015 and 2012 IBC) and allowable shear values for shear walls and diaphragms resisting wind loads must be multiplied by 1.6.

Diaphragm and shear wall deflection must be determined in accordance with Section A3.1.

4.2.5 Prescriptive Sheathing Attachments: [Table 2](#) references the code tables where nails are prescribed for attaching sheathing to framing. Carbon steel nails (bright or galvanized) shown in [Appendix B](#) as meeting the head area ratio requirements for use in lateral force resisting assemblies may be used where the same nail types and sizes are prescribed in the referenced code tables.

4.3 Installation:

The nails must be installed in accordance with this report, the listee's published installation instructions, the approved plans, if applicable, and the applicable prescriptions in the code.

Nails used with metal hardware (joist hangers, truss plates, etc.) must be installed in accordance with the metal hardware manufacturer's instructions and any applicable ICC-ES evaluation report.

The nails described in this report are packaged for use in power tools. The nails must be installed using a tool recommended by the applicable listee. Individual nails may also be manually driven.

Edge distances, end distances, and spacings must be sufficient to prevent splitting of the wood. Installation into sawn lumber must be in accordance with the applicable requirements of 2018 and 2015 NDS Section 12.1.6 (2012 NDS Section 11.1.6 for the 2012 IBC).

4.4 Special Inspection:

Periodic special inspection of nailing used in the construction of main windforce-resisting systems is required by 2021 IBC Section 1705.12.1 (2018 and 2015 IBC Section 1705.11.1, 2012 IBC Section 1705.10.1) when the nail spacing is 4 inches (102 mm) or less. Periodic special inspection of nailing used in the construction of seismic force-resisting systems is required by 2021 IBC Section 1705.13.2 (2018 and 2015 IBC Section 1705.12.2, 2012 IBC Section 1705.11.2) when the nail spacing is 4 inches (102 mm) or less.

4.5 Use in Treated Lumber:

In accordance with 2021 IBC Section 2304.10.6 (2018 and 2015 IBC Section 2304.10.5, 2012 IBC Section 2304.9.5) and IRC Section R317.3, stainless steel (SS) and hot-dip galvanized (HDG) nails listed in [Appendix B](#), may be used in preservative-treated and fire-retardant-treated lumber. Use of nails listed in [Appendix B](#) as having a proprietary coating for installation in preservative-treated lumber in specific Exposure Conditions, is addressed in [Appendix B](#) or in applicable ICC-ES evaluation reports referenced in [Appendix B](#). Nails and staples listed in [Appendix B](#) as bright must not be used in treated lumber. Use of nails and staples with other coatings in treated lumber is outside the scope of this report.

5.0 CONDITIONS OF USE:

The nails and staples described in this report comply with, or are suitable alternatives to what is specified in, those codes listed in Section 1.0 of this report, subject to the following conditions:

- 5.1 The nails and staples must be installed in accordance with this report, the listee's published installation instructions, the approved plans (if applicable), and the applicable prescriptions in the code. In the case of a conflict amongst these documents, the most restrictive requirements govern.
- 5.2 The fastener dimensions specified in the design tables in this report are minimum nominal dimensions. When fasteners larger than those specified are used for any application, consideration must be given to restrictions on edge distance and close spacing.
- 5.3 See Section 4.5 regarding use of staples and nails in treated wood.
- 5.4 The nails and staples described in [Appendix B](#) of this report are manufactured under quality control programs with inspections by ICC-ES.

6.0 EVIDENCE SUBMITTED

- 6.1 Data in accordance with the [ICC-ES Acceptance Criteria for Nails \(AC116\)](#), dated March 2018 (editorially revised July 2022).
- 6.2 Data in accordance with the [ICC-ES Acceptance Criteria for Staples \(AC201\)](#), dated March 2020 (editorially revised December 2020).

7.0 IDENTIFICATION

- 7.1 The ICC-ES mark of conformity, electronic labeling, or the evaluation report number (ICC-ES ESR-1539) along with the name, registered trademark, or registered logo of the report holder and/or listee must be included in the product label.
- 7.2 In addition, packages of nails and staples must be identified with the applicable brand name (shown in [Appendix B](#)), fastener size (nail diameter and length or staple gage, crown width and length), finish/coating designation and country of origin.



ISANTA Logo

- 7.3 The report holder's contact information is the following:
INTERNATIONAL STAPLE, NAIL AND TOOL ASSOCIATION
8735 WEST HIGGINS ROAD, SUITE 300
CHICAGO, ILLINOIS 60631
(847) 375-6454
www.isanta.org
info@isanta.org
- 7.4 The Additional Listees' contact information appears in [Table B1](#) of [Appendix B](#)

INDEX TO TABLES, FIGURES AND APPENDICES

Figure No.	Title	Page
1	Basic Fastener Styles	5

Table No.	Title	Page
1	Nail Diameters Addressed in this Report	5
2	Applicable Fastening Schedules in the Codes for Attachment of Sheathing to Framing	6
3	Reference Lateral Design Values of Face Nailed Single Shear Connections of "2-by" Members to Other Members of the Same Species	6
4	Reference Lateral Design Values of Face Nailed Single Shear Connections of Steel Side Members to Wood Members	7
5	Nail and Staple Reference Withdrawal Design Values	8

Horizontal Diaphragm Tables

6	Allowable Shear for Wind or Seismic Loading for Wood Structural Panel Horizontal Diaphragms - Structural I Sheathing	9
7	Allowable Shear for Wind or Seismic Loading for Wood Structural Panel Horizontal Diaphragms - Rated Sheathing	10
	Footnote Explanations for Horizontal Diaphragm Tables 6 and 7	11

Vertical Shear Wall Tables

8	Allowable Shear for Wind or Seismic Loading for Wood Structural Panel Shear Walls - Structural I Sheathing	12
9	Allowable Shear for Wind or Seismic Loading for Wood Structural Panel Shear Walls - Rated Sheathing	13
	Footnote Explanations for Shear Wall Tables 8 and 9	14
10	Allowable Shear for Wind or Seismic Loading for Shear Walls with Fiberboard Sheathing, Gypsum Lath, Gypsum Sheathing, Gypsum Wallboard, Lath and Plaster or Plywood Siding Over Wood Framing	15

Fastening Schedule for Framing Connections

11	Fastening Schedule – Wall Framing	16
12	Fastening Schedule – Ceiling and Roof Framing	20
13	Fastening Schedule – Floor Framing	23
14	Summary of Alternative Fastening Designs Described in Table 11 through 13	25

Appendix	Title	Page No.
A	Reference Design Information	26
B	Evaluated Fasteners by Listee	31

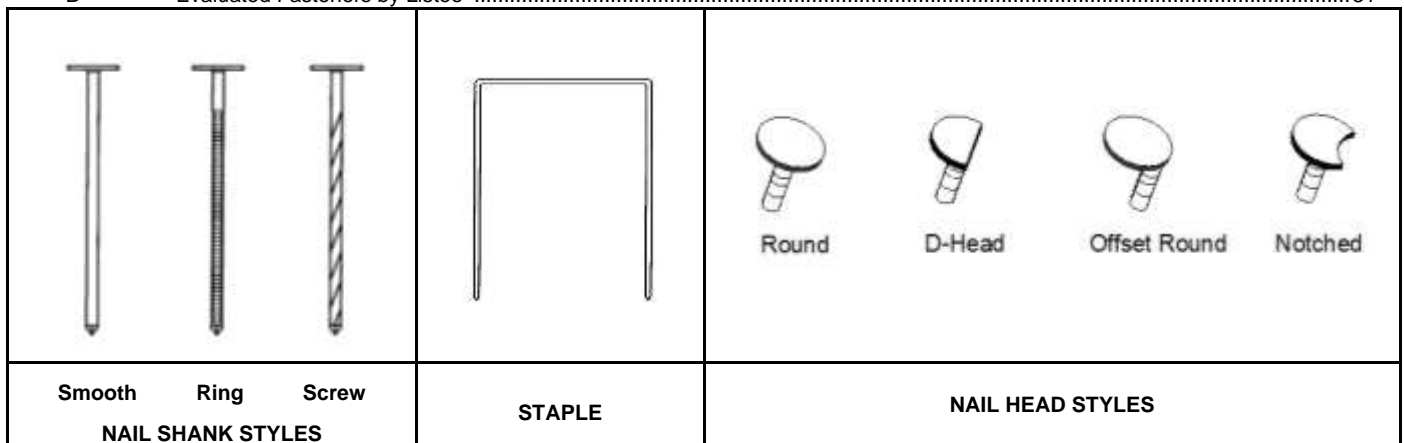

FIGURE 1—BASIC FASTENER STYLES

TABLE 1—NAIL DIAMETERS ADDRESSED IN THIS REPORT¹

SHANK DIAMETER (inch)	DESCRIBED IN ASTM F1667				OTHERS	
	TYPE AND PENNYWEIGHT	LENGTH (inches)	HEAD DIAMETER (inch)	SHANK STYLE	COMMONLY AVAILABLE LENGTHS (inches)	SHANK STYLES
0.092	6d cooler	1 ⁷ / ₈	0.250	Smooth, Ring, Screw	1 ¹ / ₄ , 1 ¹ / ₂ , 1 ⁵ / ₈ , 1 ³ / ₄ , 2, 2 ¹ / ₈ , 2 ³ / ₁₆ , 2 ¹ / ₄ , 2 ³ / ₈ , 2 ¹ / ₂	Smooth, Ring, Screw
0.099	6d box	2	0.266	Smooth	1 ¹ / ₈ , 1 ¹ / ₂ , 1 ³ / ₄ , 1 ⁷ / ₈ , 2, 2 ¹ / ₄ , 2 ³ / ₈ , 2 ¹ / ₂	Smooth, Ring, Screw
0.113	6d common	2	0.266	Smooth	2, 2 ¹ / ₄ , 2 ³ / ₈ , 2 ¹ / ₂	Smooth, Ring, Screw
	8d box	2 ¹ / ₂	0.297			
	8d cooler	2 ³ / ₈	0.281			
0.120	–	–	–	–	2, 2 ¹ / ₄ , 2 ³ / ₈ , 2 ¹ / ₂ , 2 ³ / ₄ , 3, 3 ¹ / ₄ , 3 ¹ / ₂ , 3 ³ / ₄ , 4	Smooth, Ring, Screw
0.131	8d common	2 ¹ / ₂	0.281	Smooth	2, 2 ¹ / ₄ , 2 ³ / ₈ , 2 ¹ / ₂ , 2 ³ / ₄ , 3, 3 ¹ / ₄ , 3 ³ / ₈ , 3 ¹ / ₂ , 3 ³ / ₄ , 4	Smooth, Ring, Screw
	Metal Hardware ²	1 ¹ / ₄ , 1 ¹ / ₂ , 2 ¹ / ₄ , 2 ³ / ₈ , 2 ¹ / ₂	0.281	Smooth, Ring		
0.135	16d box	3 ¹ / ₂	0.344	Smooth	2 ¹ / ₄ , 2 ³ / ₈ , 2 ¹ / ₂ , 3 ¹ / ₄ , 3 ¹ / ₂ , 4	Ring, Screw
0.148	10d common	3	0.312	Smooth	2, 2 ¹ / ₈ , 2 ¹ / ₄ , 2 ³ / ₈ , 2 ¹ / ₂ , 3, 3 ¹ / ₄ , 3 ¹ / ₂ , 4	Smooth, Ring, Screw
	12d common	3 ¹ / ₄	0.312			
	Metal Hardware ²	1 ¹ / ₄ , 1 ¹ / ₂ , 2 ¹ / ₂ , 3, 3 ¹ / ₂	0.281	Smooth, Ring		
0.162	16d common	3 ¹ / ₂	0.344	Smooth	3, 3 ¹ / ₄ , 3 ¹ / ₂ , 4	Smooth, Ring, Screw
	Metal Hardware ²	2 ¹ / ₂ , 3, 3 ¹ / ₂	0.281	Smooth, Ring		
0.180	–	–	–	–	5 ³ / ₈	Smooth
0.197	–	–	–	–	5 ³ / ₈	Smooth

For SI: 1 inch = 25.4 mm.

¹See [Appendix B](#) for evaluated nail products for each listee.

²Nails intended for use with metal hardware such as joist hangers. See [Appendix B](#) of this report for associated designations on product labels.

TABLE 2—APPLICABLE FASTENING SCHEDULES IN THE CODES FOR ATTACHMENT OF SHEATHING TO FRAMING

CONSTRUCTION	CODE	TABLE NUMBER
Roof Sheathing Attachment	2021 IBC	2304.10.2
	2018 and 2015 IBC	2304.10.1
	2012 IBC	2304.9.1
	2021, 2018, 2015 and 2012 IRC	R602.3(1), R602.3(2)
Wall Sheathing Attachment	2021 IBC	2304.10.2
	2018 and 2015 IBC	2304.10.1
	2012 IBC	2304.9.1
	2021, 2018, 2015 and 2012 IRC	R602.3(1), R602.3(2), R602.3(3)
Floor Sheathing Attachment	2021 IBC	2304.10.2
	2018 and 2015 IBC	2304.10.1
	2012 IBC	2304.9.1
	2021, 2018, 2015 and 2012 IRC	R602.3(1), R602.3(2)

TABLE 3—REFERENCE LATERAL DESIGN VALUES OF FACE NAILED SINGLE SHEAR CONNECTIONS OF “2-BY” MEMBERS TO OTHER MEMBERS OF SAME SPECIES^{1,2,3,4,5,6}

NAIL DIMENSIONS		REFERENCE LATERAL DESIGN VALUES FOR SPECIFIC GRAVITIES OF: (lbf)			
Length (inches)	Nail Shank Diameter (inches)	0.42 (e.g., Spruce-pine-fir)	0.43 (e.g., Hem-fir)	0.50 (e.g., Douglas Fir-larch)	0.55 (e.g., Southern Pine)
3 1/2	0.162	120	122	141	154
3 1/4	0.148	100	102	118	128
3	0.148	100	102	118	128
3 1/2	0.135	88	89	103	113
3 1/4	0.131	82	84	97	106
3	0.131	82	84	97	106
2 1/2	0.131	63	64	74	81
3 1/4	0.120	69	71	81	89
3	0.120	69	71	81	89
2 1/2	0.113	54	56	64	70
2 3/8	0.113	47	49	56	61
2 1/4	0.099	36	36	42	46

For **SI**: 1 inch = 25.4 mm, 1 lbf = 4.45N, 1 psi = 6.89 kPa.

¹Design values are based on a normal load duration.

²Table values must be multiplied by all applicable adjustment factors in the NDS.

³Table is based upon a 1 1/2-inch actual thickness of both attached member and receiving (“main”) member.

⁴Design values are for connections in which the nail shank is driven into the side grain with shank axis perpendicular to wood fibers. Tabulated values are based on a minimum fastener bending yield strength (F_{yb}) of 100,000 psi for nail diameters of 0.135 inch or less, and a minimum fastener bending yield strength (F_{yb}) of 90,000 psi for nail diameters of 0.148 and 0.162 inch.

⁵Calculations are based on a connection in which both members have the same specific gravity.

⁶Reference lateral design values apply to nails with either a smooth shank or a deformed shank.

TABLE 4—REFERENCE LATERAL DESIGN VALUES OF FACE NAILED SINGLE SHEAR CONNECTIONS OF STEEL SIDE MEMBERS TO WOOD MEMBERS^{1,2,3,4}

STEEL SIDE MEMBER THICKNESS ⁶ (inch)	REFERENCE LATERAL DESIGN VALUES FOR SPECIFIC GRAVITIES ⁵ OF: (lbf)														
	0.42 (e.g., Spruce-pine-fir)					0.50 (e.g., Douglas Fir-larch)					0.55 (e.g., Southern Pine)				
	Nail Diameter (inch)					Nail Diameter (inch)					Nail Diameter (inch)				
	0.131		0.148		0.162	0.131		0.148		0.162	0.131		0.148		0.162
	Nail Length (inches)					Nail Length (inches)					Nail Length (inches)				
	1½	2¼, 2¾, 2½	1½	2½, 3, 3½	2½, 3, 3½	1½	2¼, 2¾, 2½	1½	2½, 3, 3½	2½, 3, 3½	1½	2¼, 2¾, 2½	1½	2½, 3, 3½	2½, 3, 3½
ASTM A653, Grade 33 Steel Side Plate															
0.033 - 0.036	82	82	97	97	117	94	94	112	113	136	102	102	122	123	147
0.044 - 0.048	83	83	97	98	117	95	95	112	114	136	102	102	122	124	148
0.055 - 0.060	84	84	97	99	118	96	96	113	115	138	104	104	122	125	149
0.068 - 0.075	86	86	98	102	121	98	98	114	118	140	106	106	123	127	151
0.097 - 0.105	93	93	103	108	127	105	105	118	125	147	113	113	128	135	159
0.127 - 0.134	102	102	109	118	137	115	115	126	135	157	124	124	135	146	170
0.171 - 0.179	116	116	123	137	157	132	132	138	154	177	142	142	149	166	190
0.228 - 0.240	111	116	119	140	168	127	132	137	160	192	138	144	148	174	209
ASTM A653, Grade 40 Steel Side Plate															
0.033 - 0.036	83	83	97	98	117	95	95	113	114	137	103	103	123	124	149
0.044 - 0.048	84	84	98	99	118	96	96	114	116	138	104	104	123	125	150
0.055 - 0.060	86	86	99	101	120	98	98	115	117	141	106	106	124	127	151
0.068 - 0.075	89	89	101	104	123	101	101	117	121	144	109	109	126	130	155
0.097 - 0.105	97	97	107	113	132	110	110	123	130	155	118	118	133	140	164
0.127 - 0.134	108	108	115	124	143	122	122	133	143	168	131	131	143	154	178
0.171 - 0.179	116	116	127	141	167	133	133	145	161	193	145	145	157	175	203
0.228 - 0.240	112	116	120	141	169	128	133	137	161	193	139	145	149	175	210
ASTM A36, Steel Side Plate															
0.250	111	117	117	139	169	128	134	137	162	194	139	145	157	186	222

For **SI**: 1 inch = 25.4 mm, 1 lbf = 4.45N, 1 psi = 6.89 kPa.

¹Design values are for normal load duration and must be multiplied by all applicable adjustment factors in the NDS.

²The tabulated values have been calculated in accordance with the Yield Mode Equations in [Appendix A1.2](#). Dowel bearing strengths (F_{es}) used to calculate design values are 61,850 psi for ASTM A653, Grade 33; 75,600 psi for ASTM A653 Grade 40; and 87,000 psi for ASTM A36 side member material.

³Lateral design values are based on $F_{yb} = 100,000$ psi for 0.131-inch diameter nails; and $F_{yb} = 90,000$ psi for 0.148 and 0.162-inch diameter nails.

⁴Wood member must be of sufficient thickness for the nail point to be fully embedded in the wood.

⁵Specific Gravity values must be the assigned specific gravity from [Table A](#) or NDS Table 12.3.3A (2012 NDS Table 11.3.3A for the 2012 IBC) or the equivalent specific gravity for engineered wood products, as shown in an ICC-ES evaluation report.

⁶These thicknesses are base metal thicknesses and are based on typical steel thicknesses described in various ICC-ES evaluation reports for metal hardware and on the thicknesses addressed in Table 12P of the 2018 and 2015 NDS.

TABLE 5—NAIL AND STAPLE REFERENCE WITHDRAWAL DESIGN VALUES^{1,2,3} (pounds-force per inch of penetration)

SPECIFIC GRAVITY ⁴	SMOOTH AND DEFORMED ⁵ SHANK CARBON STEEL NAILS (BRIGHT OR GALVANIZED), DIAMETER IN INCHES										SMOOTH AND DEFORMED ⁵ SHANK STAINLESS STEEL NAILS, DIAMETER IN INCHES								STAPLE GAGE AND DIAMETER ⁶ , in inches		
	0.092	0.099	0.113	0.120	0.131	0.135	0.148	0.162	0.180	0.197	0.092	0.099	0.113	0.120	0.131	0.135	0.148	0.162	16 gage	15 gage	14 gage
																			0.063	0.072	0.080
0.31	7	7	8	9	10	10	11	12	13	15	7	8	9	10	11	11	12	13	9	11	12
0.35	9	10	11	12	13	14	15	16	18	20	9	10	11	12	13	13	14	16	13	14	16
0.36	10	10	12	13	14	14	16	17	19	21	9	10	11	12	13	14	15	16	13	15	17
0.37	11	11	13	14	15	16	17	19	21	23	10	10	12	13	14	14	15	17	14	17	18
0.38	11	12	14	15	16	17	18	20	22	24	10	11	12	13	14	15	16	18	15	18	20
0.39	12	13	15	16	17	18	19	21	24	26	10	11	13	14	15	15	17	18	16	19	21
0.40	13	14	16	17	18	19	21	23	25	28	11	12	13	14	15	16	17	19	17	20	22
0.41	14	14	17	18	19	20	22	24	27	29	11	12	14	15	16	16	18	20	19	21	24
0.42	15	15	18	19	21	21	23	26	28	31	12	13	14	15	17	17	19	21	20	23	25
0.43	15	16	19	20	22	23	25	27	30	33	12	13	15	16	17	18	19	21	21	24	27
0.44	16	17	20	21	23	24	26	29	32	35	12	13	15	16	18	18	20	22	22	26	28
0.46	18	19	22	24	26	27	29	32	36	39	13	14	16	17	19	20	21	24	25	29	32
0.47	19	20	24	25	27	28	31	34	38	41	14	15	17	18	20	20	22	24	26	30	33
0.49	21	22	26	28	30	31	34	38	42	46	15	16	18	19	21	22	24	26	29	33	37
0.50	22	24	28	29	32	33	36	40	44	48	15	16	19	20	22	22	24	27	30	35	39
0.51	24	25	29	31	34	35	38	42	46	50	16	17	19	20	22	23	25	27	32	37	41
0.55	28	30	35	37	41	42	46	50	56	61	17	19	21	23	25	26	28	31	39	45	50
0.58	33	34	40	42	46	48	52	57	64	70	19	20	23	25	27	28	30	33	44	51	57
0.67	47	49	57	61	66	68	75	82	91	100	23	25	29	31	33	34	38	41	63	73	81
0.68	48	51	59	63	69	71	78	85	95	104	24	26	29	31	34	35	39	42	66	76	84
0.71	54	57	66	70	77	79	87	95	106	115	26	28	31	33	36	38	41	45	73	84	94
0.73	58	61	71	75	82	85	93	102	113	124	27	29	33	35	38	39	43	47	79	90	101

For **SI**: 1 inch = 25.4 mm, 1 pound-force per inch = 0.175 N/mm.

¹Design values are based on a normal (10 year) duration of load.

²Table values must be multiplied by all applicable adjustment factors in the NDS.

³Withdrawal strengths are for fasteners driven perpendicular to the grain.

⁴Specific Gravity values must be the assigned specific gravity from [Table A](#) or NDS Table 12.3.3A (2012 NDS Table 11.3.3A for the 2012 IBC) or the equivalent specific gravity for engineered wood products, as shown in an ICC-ES evaluation report.

⁵Applies to deformed nails addressed in this report.

⁶Values account for both staple legs.

TABLE 6—ALLOWABLE SHEAR FOR WIND OR SEISMIC LOADING FOR WOOD STRUCTURAL PANEL HORIZONTAL DIAPHRAGMS WITH FRAMING OF DOUGLAS FIR-LARCH OR SOUTHERN PINE AND STRUCTURAL I SHEATHING (plf)^{1,2,3,4,5,6,7,8,9}

NOMINAL NAIL DIAMETER (inch) or STAPLE GAGE Nails must be smooth or deformed, and must be carbon steel (bright or galvanized).	MINIMUM REQUIRED FASTENER LENGTH (inches)	MINIMUM WIDTH OF FRAMING MEMBER (inches)	BLOCKED DIAPHRAGMS FASTENER SPACING (inch) AT DIAPHRAGM BOUNDARIES (ALL CASES), AT CONTINUOUS PANEL EDGES PARALLEL TO LOAD (CASES 3, 4), AND AT ALL PANEL EDGES (CASES 5 & 6)								UNBLOCKED DIAPHRAGMS FASTENERS SPACED 6" MAX. AT DIAPHRAGM BOUNDARIES AND ALL SUPPORTED EDGES			
			6		4		2 1/2		2		Case 1		All other configurations (Cases 2, 3, 4, 5 & 6)	
			Fastener spacing at other panel edges (Cases 1, 2, 3 & 4)											
			6		6		4		3					
			Seismic	Wind	Seismic	Wind	Seismic	Wind	Seismic	Wind	Seismic	Wind	Seismic	Wind
3/8-inch Nominal Panel Thickness														
0.131	1 3/4	2	270	375	360	505	530	740	600	840	240	335	180	255
			300	420	400	560	600	840	675	945	265	370	200	280
0.120	1 3/4	2	230	320	305	435	455	635	515	720	200	290	150	220
			255	360	340	480	510	720	580	810	225	320	170	240
0.113	1 3/4	2	205	290	275	390	410	570	465	645	180	260	135	200
			230	325	305	430	460	645	520	725	205	285	155	215
14, 15, 16 Gage	1 1/2 Leg Length	2	175	245	235	330	350	490	400	560	155	215	115	160
			200	280	265	370	395	550	450	630	175	245	130	180
15/32-inch Nominal Panel Thickness														
0.148 smooth	2	2	320	445	425	595	640	895	730	1025	285	400	215	300
			360	505	480	670	720	1005	820	1150	320	445	240	335
0.135	2	2	285	395	380	530	570	795	650	910	255	355	195	270
			320	450	430	595	640	895	730	1020	285	395	215	300
0.131	2	2	270	375	360	505	540	755	610	865	240	340	180	255
			305	425	405	565	605	845	685	970	270	375	200	285
0.120	2	2	230	325	310	435	465	650	525	745	205	290	155	220
			260	370	350	490	520	730	590	835	230	325	175	245
0.113	2	2	210	295	280	395	420	590	475	675	185	265	140	200
			235	335	315	440	470	660	535	755	210	295	155	220
14, 15, 16 Gage	1 1/2 Leg Length	2	175	245	235	330	350	490	400	560	155	215	120	160
			200	280	265	370	395	550	450	630	175	245	130	180

See [page 11](#) for footnote explanations and case diagrams.

TABLE 7—ALLOWABLE SHEAR FOR WIND OR SEISMIC LOADING FOR WOOD STRUCTURAL PANEL HORIZONTAL DIAPHRAGMS WITH FRAMING OF DOUGLAS FIR-LARCH OR SOUTHERN PINE AND RATED SHEATHING (plf)^{1,2,3,4,5,6,7,8,9}

NOMINAL NAIL DIAMETER (inch) or STAPLE GAGE Nails must be smooth or deformed and must be carbon steel (bright or galvanized).	MINIMUM REQUIRED FASTENER LENGTH (inches)	MINIMUM WIDTH OF FRAMING MEMBER (inches)	BLOCKED DIAPHRAGMS								UNBLOCKED DIAPHRAGMS					
			FASTENER SPACING (inch) AT DIAPHRAGM BOUNDARIES (ALL CASES), AT CONTINUOUS PANEL EDGES PARALLEL TO LOAD (CASES 3, 4), AND AT ALL PANEL EDGES (CASES 5 & 6)										FASTENERS SPACED 6" MAX. AT DIAPHRAGM BOUNDARIES AND ALL SUPPORTED EDGES			
			6		4		2 1/2		2		Case 1 All other configurations (Cases 2, 3, 4, 5 & 6)					
			Fastener spacing at other panel edges (Cases 1, 2, 3 & 4)													
			6		6		4		3		Seismic Wind		Seismic Wind		Seismic Wind	
Seismic	Wind	Seismic	Wind	Seismic	Wind	Seismic	Wind									
3/8-inch Nominal Panel Thickness																
0.131	1 3/4	2 3	240 270	335 375	320 360	445 505	480 540	670 755	545 610	760 855	215 240	300 335	160 180	225 250		
0.120	1 3/4	2 3	205 230	285 315	270 305	375 425	405 455	565 640	460 515	640 720	180 205	255 285	135 150	190 210		
0.113	1 3/4	2 3	180 205	255 285	240 270	335 380	360 405	505 570	410 460	575 645	160 180	225 255	120 135	170 190		
14, 15, 16 Gage	1 1/2 Leg Length	2 3	160 180	225 250	210 235	295 330	315 355	440 495	360 400	505 560	140 160	195 225	105 120	145 170		
7/16-inch Nominal Panel Thickness																
0.131	2	2 3	255 285	360 400	340 380	475 530	505 570	705 800	575 645	805 900	230 255	320 355	170 190	235 265		
0.120	2	2 3	215 240	305 340	290 325	405 450	430 485	600 680	490 550	685 765	190 215	270 300	145 160	200 225		
0.113	2	2 3	195 215	275 305	260 290	360 405	385 435	540 610	440 490	615 685	175 195	245 270	130 145	180 200		
14, 15, 16 Gage	1 1/2 Leg Length	2 3	165 190	230 265	225 250	315 350	335 375	470 525	380 425	530 595	150 165	210 230	110 125	155 175		
1 5/32-inch Nominal Panel Thickness																
0.148	2	2 3	290 325	405 455	385 430	540 605	575 650	805 910	655 735	920 1030	255 290	360 405	190 215	265 300		
0.135	2	2 3	255 285	355 400	340 380	475 530	505 575	710 800	580 650	810 910	225 255	315 355	170 190	235 265		
0.131	2	2 3	270 300	380 420	360 400	505 560	530 600	740 840	600 675	840 945	240 265	335 370	180 200	255 280		
0.120	2	2 3	230 255	325 360	305 340	430 480	450 510	630 715	510 575	715 805	205 225	285 315	155 170	220 240		
0.113	2	2 3	205 230	290 320	275 305	385 430	405 460	570 645	460 520	645 725	185 205	255 285	140 155	195 215		
14, 15, 16 Gage	1 1/2 Leg Length	2 3	160 180	225 250	210 235	295 330	315 355	440 495	360 405	505 565	140 160	195 225	105 120	145 170		
1 9/32-inch Nominal Panel Thickness¹⁰																
0.148	2 1/4	2 3	320 360	445 505	425 480	595 675	640 720	895 1010	730 820	1025 1150	285 320	400 445	215 240	300 335		
0.135	2 1/4	2 3	285 320	395 450	375 425	525 595	565 640	795 895	645 725	905 1020	255 285	355 395	190 215	265 295		
0.131	2 1/4	2 3	270 305	375 425	360 405	500 565	540 605	755 850	615 690	860 965	240 270	335 375	180 200	255 285		
0.120	2 1/4	2 3	235 260	325 365	310 350	435 490	465 525	650 735	530 595	745 835	205 235	290 325	155 175	220 245		
0.113	2 1/4	2 3	210 240	295 335	280 315	395 445	420 475	590 665	480 540	675 760	190 210	265 295	140 160	200 220		
14, 15, 16 Gage	1 1/2 Leg Length	2 3	175 200	245 280	235 265	330 370	350 395	490 555	400 450	560 630	155 175	215 245	115 130	160 180		

See [page 11](#) for footnote explanations and case diagrams

FOOTNOTE EXPLANATIONS FOR HORIZONTAL DIAPHRAGM TABLES 6 AND 7

¹For SI: 1 inch = 25.4 mm, 1 plf = 14.6 N/m.

²Diaphragm construction using nails must be in accordance with Sections 4.2.7 and 4.2.8 of the 2021 ANSI/AWC Special Design Provisions for Wind and Seismic (SPDWS) (Sections 4.2.6. and 4.2.7 of the 2015 and 2008 SDPWS for the 2018, 2015 and 2012 IBC), and diaphragm construction using staples must be in accordance with 2021, 2018 and 2015 IBC Tables 2306.2(1) and 2306.2(2) (similar for earlier codes), as applicable.

³Tabulated values are for short-time loading due to wind or seismic. The tabulated seismic values must be reduced by 37 percent and 44 percent for normal and permanent load duration, respectively.

⁴The tabulated values are for fasteners installed in Douglas Fir-larch or Southern Pine framing. For framing of other species: (1) Find the assigned specific gravity for the applicable species of lumber (see Section A1.3). (2) For staples find the shear value from [Table 6](#) (regardless of actual sheathing grade) and multiply the value by 0.82 for species with specific gravity of 0.42 or greater, or by 0.65 for all other species. (3) For nails find the shear value from the applicable table and multiply value by the Specific Gravity Adjustment Factor = [1 - (0.5 - G)], where G = Specific Gravity of the framing lumber. This adjustment factor must not be greater than 1.

⁵Diaphragm deflection must be determined in accordance with Section A3.0.

⁶Structural I panels must comply with DOC PS1 or PS2. Rated Sheathing includes Sheathing and Single-Floor grades and must comply with DOC PS1 or PS2.

⁷Nails must be bright or galvanized carbon steel, flat head nails denoted in [Appendix B](#) as meeting the head area ratio requirements for lateral force resisting assemblies. A deformed shank nail must have either a helical (screw) shank or an annular (ring) shank. Diaphragm values for stainless steel nails are outside the scope of this report.

⁸Staples must have a 7/16-inch minimum crown width and must be installed with their crowns parallel to the long dimension of the framing members and must be driven flush with the surface of the sheathing.

⁹Space fasteners maximum 12" o.c. along intermediate framing members (6 in. o.c. when supports are spaced 48 inches o.c.).

¹⁰Tabulated values apply to wood structural panels up to 1 1/8" in thickness, provided the nail penetration is at least 1 1/2 inches and the staple penetration is at least 1 inch.

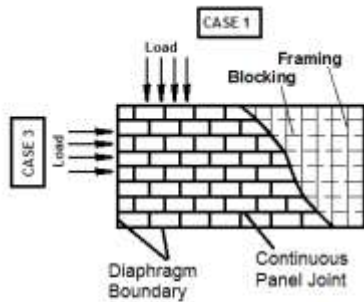

Continuous Panel Joints Perpendicular to Framing
Long Panel Direction Perpendicular to Support

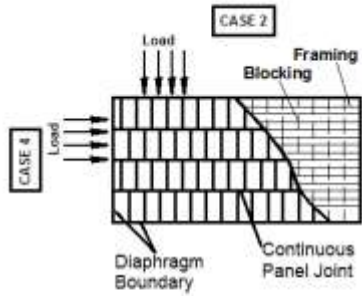

Continuous Panel Joints Parallel to Framing
Long Panel Direction Perpendicular to Supports

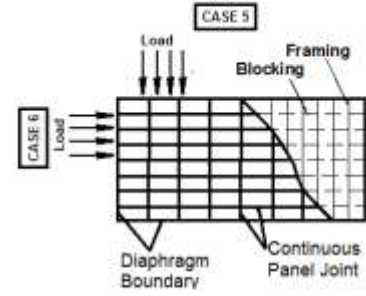

Continuous Panel Joints Perpendicular and Parallel
To Framing
Long Panel Direction Perpendicular to Supports

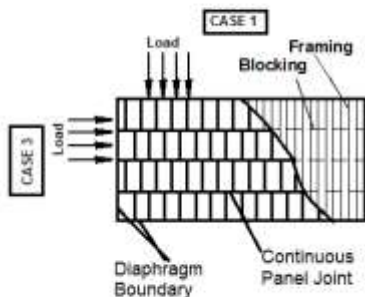

Continuous Panel Joints Perpendicular to Framing
Long Panel Direction Parallel to Supports

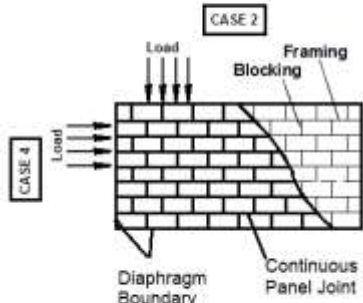

Continuous Panel Joints Parallel to Framing
Long Panel Direction Parallel to Supports

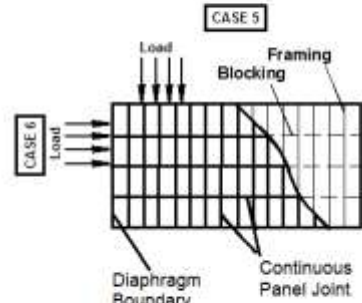

Continuous Panel Joints Perpendicular and Parallel
To Framing
Long Panel Direction Parallel to Supports

CASE DIAGRAMS FOR HORIZONTAL DIAPHRAGM [TABLE 6](#)
(Similar for [Table 7](#), except no blocking)

TABLE 8—ALLOWABLE SHEAR FOR WIND OR SEISMIC LOADING FOR WOOD STRUCTURAL PANEL SHEAR WALLS WITH FRAMING OF DOUGLAS FIR-LARCH OR SOUTHERN PINE AND STRUCTURAL I SHEATHING (plf)^{1,2,3,4,5,6,7,8,9,10,11}

NOMINAL NAIL DIAMETER (inch) or STAPLE GAGE Nails must be smooth and must be carbon steel (bright or galvanized)	MINIMUM NOMINAL FASTENER LENGTH (inches)		SEISMIC				WIND			
	Panels Applied Directly to Framing	Panels Applied Over 1/2 inch or 5/8 inch Gypsum Sheathing	Fastener Spacing at Panel Edges (inches)				Fastener Spacing at Panel Edges (inches)			
			6	4	3	2	6	4	3	2
3/8-inch Nominal Panel Thickness										
0.148	2	—	230	360	460	610	320	505	645	855
	—	2 1/2	280	430	550	730	390	600	770	1020
0.135	2	—	230	360	460	610	320	505	645	855
	—	2 1/2	250	380	485	645	345	530	680	900
0.131	1 3/4	—	230	360	460	610	320	505	645	855
	—	2 1/2	235	360	460	610	330	505	645	855
0.120	1 3/4	—	200	310	395	520	275	435	550	730
	—	2 1/2	200	310	395	520	280	430	550	725
0.113	1 3/4	—	180	280	355	470	245	390	495	655
	—	2 1/2	180	275	355	470	250	385	495	655
14, 15, 16 Gage	1 1/2	—	155	235	315	400	215	330	440	560
14, 15, 16 Gage	—	2	155	235	310	400	215	330	435	560
7/16-inch Nominal Panel Thickness										
0.148	2	—	260	395	505	670	355	550	705	935
	—	2 1/2	280	430	550	730	390	600	770	1020
0.135	2	—	260	395	505	670	355	550	705	935
	—	2 1/2	250	385	490	650	345	535	685	905
0.131	2	—	260	395	505	670	355	550	705	935
	—	2 1/2	235	365	465	615	330	505	650	860
0.120	2	—	225	340	435	580	305	475	610	805
	—	2 1/2	205	310	400	530	285	435	555	735
0.113	2	—	205	310	395	520	280	430	550	730
	—	2 1/2	170	260	330	440	235	360	460	610
14, 15, 16 Gage	1 1/2	—	170	260	345	440	240	365	485	615
14, 15, 16 Gage	—	2	155	235	310	400	215	330	435	560
15/32-inch Nominal Panel Thickness										
0.148	2	—	340	510	665	870	475	715	930	1215
	—	2 1/2	280	430	550	730	390	600	770	1020
0.135	2	—	305	455	590	775	425	635	825	1080
	—	2 1/2	250	385	490	650	350	535	685	905
0.131	2	—	280	430	550	730	390	600	770	1020
	—	2 1/2	240	365	465	615	330	505	650	860
0.120	2	—	245	375	475	630	340	520	665	880
	—	2 1/2	205	315	400	530	285	435	560	740
0.113	2	—	220	340	430	570	305	470	605	800
	—	2 1/2	185	285	365	480	260	395	510	670
14, 15, 16 Gage	1 1/2	—	185	280	375	475	260	390	525	665
14, 15, 16 Gage	—	2	155	235	300	400	215	330	420	560

See [page 17](#) for footnote explanations.

TABLE 9—ALLOWABLE SHEAR FOR WIND OR SEISMIC LOADING FOR WOOD STRUCTURAL PANEL SHEAR WALLS WITH FRAMING OF DOUGLAS FIR-LARCH OR SOUTHERN PINE AND RATED SHEATHING (plf)^{1,2,3,4,5,6,7,8,9,10,11}

NOMINAL NAIL DIAMETER (inch) or STAPLE GAGE Nails must be smooth and must be carbon steel (bright or galvanized)	MINIMUM NOMINAL FASTENER LENGTH (inches)		SEISMIC				WIND			
	Panels Applied Directly to Framing	Panels Applied Over 1/2 inch or 5/8 inch Gypsum Sheathing	Fastener Spacing at Panel Edges (inches)				Fastener Spacing at Panel Edges (inches)			
			6	4	3	2	6	4	3	2
3/8-inch Nominal Panel Thickness										
0.148	2	—	220	320	410	530	305	445	575	740
	—	2 1/2	260	380	490	640	365	530	685	895
0.135	2	—	220	320	410	530	305	445	575	740
	—	2 1/2	230	335	430	560	320	465	600	785
0.131	1 3/4	—	220	320	410	530	305	445	575	740
	—	2 1/4	200	300	390	510	280	420	545	715
0.120	1 3/4	—	185	270	345	450	260	375	485	625
	—	2 1/2	170	255	330	430	235	355	460	605
0.113	1 3/4	—	200	300	390	510	280	420	545	715
	—	2 1/4	150	225	295	385	210	315	410	540
14, 15, 16 Gage	1 1/2	—	140	210	280	360	195	295	390	505
14, 15, 16 Gage	—	2	140	210	280	360	195	295	390	505
7/16-inch Nominal Panel Thickness										
0.148	2 1/2	—	240	350	450	585	335	490	630	820
	—	2 1/2	260	380	490	640	365	530	685	895
0.135	2	—	240	350	450	585	335	490	630	820
	—	2 1/2	230	335	435	565	320	465	605	790
0.131	2	—	240	350	450	585	335	490	630	820
	—	2 1/2	215	315	410	535	305	440	570	745
0.120	2	—	205	300	385	495	285	415	535	695
	—	2 1/2	185	270	345	455	260	375	485	635
0.113	2	—	185	265	345	445	255	375	480	625
	—	2 1/2	165	240	310	405	230	335	435	570
14, 15, 16 Gage	1 1/2	—	155	230	310	395	215	320	435	555
14, 15, 16 Gage	—	2	140	210	280	360	195	295	390	505
15/32-inch Nominal Panel Thickness										
0.148	2	—	310	460	600	770	435	645	840	1075
	—	2 1/2	260	380	490	640	365	530	685	895
0.135	2	—	275	405	530	680	385	570	740	950
	—	2 1/2	230	335	430	565	320	465	605	790
0.131	2	—	260	380	490	640	365	530	685	895
	—	2 1/2	215	315	410	535	305	440	570	745
0.120	2	—	220	325	420	545	310	450	585	765
	—	2 1/2	185	270	350	455	260	375	490	635
0.113	2	—	200	290	375	490	280	405	525	685
	—	2 1/2	165	245	315	410	235	340	440	575
14, 15, 16 Gage	1 1/2	—	170	255	335	430	240	355	470	600
14, 15, 16 Gage	—	2	140	210	280	360	195	295	390	505
19/32-inch Nominal Panel Thickness										
0.148	2 1/4	—	340	510	665	870	475	715	930	1215
0.135	2 1/4	—	300	450	590	770	420	635	825	1075
0.131	2 1/4	—	285	430	560	735	400	600	785	1025
0.120	2 1/4	—	245	370	485	635	345	520	675	885
0.113	2 1/4	—	225	335	440	575	315	470	615	800
14, 15, 16 Gage	1 3/4	—	185	280	375	475	260	390	525	665

See page 17 for footnote explanations.

FOOTNOTE EXPLANATIONS FOR SHEAR WALL TABLES 8 AND 9

¹For **SI**: 1 inch = 25.4 mm, 1 plf = 14.6 N/m.

²Shear wall construction using nails must be in accordance with Section 4.3.6 and 4.3.7 of the ANSI/AWC Special Design Provisions for Wind and Seismic (SDPWS), and shear wall construction using staples must be in accordance with 2021, 2018 and 2015 IBC Table 2306.3(1) (similar for earlier codes), as applicable.

³Tabulated values are for short-time loading due to wind or seismic. The tabulated seismic values must be reduced by 37 percent and 44 percent for normal and permanent load duration, respectively.

⁴The tabulated values are for fasteners installed in Douglas Fir-larch or Southern Pine. For framing of other species: (1) Find the assigned specific gravity for species of lumber (see Section A1.3) (2) For staples find shear value from [Table 8](#) (regardless of actual sheathing grade) and multiply value by 0.82 for species with specific gravity of 0.42 or greater, or 0.65 for all other species. (3) For nails find shear value from the applicable table and multiply by the following Specific Gravity Adjustment Factor = $[1 - (0.5 - G)]$, where G = Assigned Specific Gravity of the framing lumber. This adjustment factor must not be greater than 1.

⁵Shear wall deflection must be determined in accordance with Section A3.0.

⁶Structural I and Rated Sheathing panels must comply with DOC PS1 or PS2. Install panels either horizontally or vertically. All panel edges must be backed by framing members.

⁷In structures assigned to Seismic Design category D, E, or F, where the allowable shear design value exceeds 350 plf, all framing members receiving edge nailing from abutting panels must not be less than a single 3-inch nominal member. Panel joint and sill plate nailing must be staggered in all cases. See Section 4.3.6.4 of SDPWS for sill plate size and anchorage requirements, as applicable.

⁸Space fasteners maximum 6 inches on center along intermediate framing members - Exception: When panel thickness is greater than $\frac{7}{16}$ -inch or studs are spaced less than 24 inches on center, space fasteners maximum 12 inches on center.

⁹Nails must be bright or galvanized carbon steel, flat head nails denoted in [Appendix B](#) as meeting the head area ratio requirements for lateral force resisting assemblies. A deformed shank nail must have either a helical (screw) shank or an annular (ring) shank. Shear wall values for stainless steel nails are outside the scope of this report.

¹⁰Staples must have a $\frac{7}{16}$ -inch minimum crown width and must be installed with their crown parallel to the long dimension of the framing members, and must be driven flush with the surface of the sheathing.

¹¹The values for $\frac{3}{8}$ -inch and $\frac{7}{16}$ -inch panels applied directly to framing using nails may be increased to values shown for $\frac{15}{32}$ -inch-thick panels of the same panel grade, provided studs are spaced a maximum of 16 inches on center or panels are applied with long dimension across studs.

TABLE 10—ALLOWABLE SHEAR FOR WIND OR SEISMIC LOADING FOR SHEAR WALLS WITH FIBERBOARD SHEATHING, GYPSUM LATH, GYPSUM SHEATHING, GYPSUM WALLBOARD, LATH AND PLASTER OR PLYWOOD SIDING OVER WOOD FRAMING (plf)^{1,3,4,5}

SHEATHING MATERIAL	THICKNESS OF MATERIAL	WALL CONSTRUCTION	REQUIRED SPACING (inches on center)		SHEAR VALUE (plf)		FASTENER SPECIFICATIONS	COMMENTS			
			Panel Edges	Field	Seismic	Wind					
Fiberboard Sheathing	1/2"	Blocked	4	6	150	210	1 1/4" long, 16, 15 & 14 gage staple	Reference IBC Table 2306.3(2) for applicable notes			
			3		200	280					
			2		225	315					
			4		220	310					
			3		290	405					
	25/32"	Blocked	2	6	325	455	1 1/4" long, 1" crown, 16, 15 & 14 gage staple				
			4		150	210					
			3		200	280					
			2		225	315					
			4		220	310					
3/8" + 1/2" Plaster	Unblocked	Blocked	3	6	290	405	1 1/2" long, 1" crown, 16, 15 & 14 gage staple				
			2		325	455					
			4		150	210					
			3		200	280					
			2		225	315					
Gypsum Lath	3/8" + 1/2" Plaster	Unblocked	5		100		1 1/8" long, 3/4" crown, 16, 15 & 14 gage staple				
Gypsum Sheathing	1/2" x 2' x 8'	Unblocked	4		75		1 3/4" long, 16, 15 & 14 gage staple				
	1/2" x 4'	Blocked			175 ²						
		Unblocked	7		100						
Gypsum Wallboard	1/2"	Unblocked	7	6	75 ²	100	1 1/2" long, 16, 15 & 14 gage staple	Reference IBC Table 2306.3(3) for applicable notes			
			4		110 ²						
			7		125						
			4		150						
			7		115 ²						
	5/8"	Unblocked	Blocked	4	6	145 ²	150		1 5/8" long, 16, 15 & 14 gage staple		
				7		145					
				4		175					
				Blocked two-ply		250				1 5/8" long, 16, 15 & 14 gage staple	
				Face Ply - 7							2 1/4" long, 15 & 14 gage staple
Expanded metal or woven wire lath and Portland cement plaster	7/8"	Unblocked	6" On Center @ Each Framing Member		180		7/8" long, 3/4" crown, 16, 15 & 14 gage staple				
Plywood Panel Siding Shear Walls with Framing of Douglas Fir-Larch or Southern Pine ²	3/8"	Panels Applied Directly To Framing	6	6	160	225	2 1/2 x 0.113 smooth nail (carbon steel)	Reference SDPWS Table 4.3A for applicable notes			
			4		240	335					
			3		310	435					
			2		410	575					
			6		140	195					
			Panels Applied Over 1/2" or 5/8" Gypsum Sheathing	6	4	6	210		295	1 1/2" long, 16, 15 & 14 gage staple	
					3		280		390		
					2		360		505		
					6		160		225		
					4		240		335		
		Panels Applied Over 1/2" or 5/8" Gypsum Sheathing	6	6	3	6	310		435	3 x 0.131 smooth nail (carbon steel)	Reference SDPWS Table 4.3B for applicable notes
					2		410		575		
					6		140		195		
					4		210		295		
					3		280		390		
2	360	505	2" long, 16, 15 & 14 gage staple	Reference IBC Table 2306.3(1) for applicable notes							

For SI: 1 inch = 25.4 mm; 1 foot = 305 mm; 1 plf = 14.6 N/m.

¹Shear values are based on maximum framing spacing of 16 inches on center, unless otherwise noted.

²Shear values are based on maximum framing spacing of 24 inches on center.

³Staples must have a minimum crown width of 7/16 inch, measured outside the legs, unless otherwise noted.

⁴Nails must be bright or galvanized carbon steel, flat head nails denoted in [Appendix B](#) as meeting the head area ratio requirements for lateral force resisting assemblies. Shear wall values for stainless steel nails are outside the scope of this report.

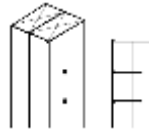

⁵In addition to requirements presented above for fastening of shear walls all other requirements of the applicable model code (such as, but not limited to, conditions of use and modification of design values for certain Seismic Design Categories) pertaining to shear wall design and construction must be met.

TABLE 11—FASTENING SCHEDULE—WALL FRAMING

CONNECTION DESCRIPTION	MINIMUM FASTENING REQUIREMENTS PRESCRIBED IN THE CODE								ALTERNATIVE FASTENING REQUIREMENTS			
	2012 IBC Table 2304.9.1		2015 IBC Table 2304.10.1		2018 IBC Table 2304.10.1		2021 IBC ⁽¹⁾ Table 2304.10.2		All nails are carbon steel. ⁽¹⁾			
	2012 IRC Table R602.3(1)		2015 IRC Table R602.3(1)		2018 IRC Table R602.3(1)		2021 IRC ⁽¹⁾ Table R602.3(1)					
#	Nail Size [Type (inch)]	#	Nail Size [Type (inch)]	#	Nail Size [Type (inch)]	#	Nail Size [Type (inch)]	#	Nail Size [Type (inch)]	#	Nail Size [Type (inch)]	
Stud-to-stud (double studs) not at braced walls 	IBC Connection 9		IBC Connection 8		IBC Connection 8		IBC Connection 8		@ 24" o.c.		@ 16" o.c.	
	@ 24" o.c.		@ 24" o.c.		@ 24" o.c.		@ 24" o.c.		1 16d com (3 1/2 x .162)		1 12d com (3 1/4 x .148)	
	1	16d box (3 1/2 x .135)	1	16d com (3 1/2 x .162)	1	16d com (3 1/2 x .162)	1	16d com (3 1/2 x .162)	1 10d com (3 x .148)		1 16d box (3 1/2 x .135)	
	@ 8" o.c.		@ 16" o.c.		@ 16" o.c.		@ 16" o.c.		1 3 1/4 x .131		1 3 x .131	
	1	3 x .131	1	3 x .131	1	3 x .131	1	3 x .131	1 3 1/4 x .131		1 3 x .131	
	IRC Connection 12		IRC Connection 8		IRC Connection 8		IRC Connection 8		@ 8" o.c.		1 8d com (2 1/2 x .131)	
	@ 24" o.c.		@ 24" o.c.		@ 24" o.c.		@ 24" o.c.		1 3 1/4 x .120		1 3 x .120	
	1	10d box (3 x .128)	1	16d com (3 1/2 x .162)	1	16d com (3 1/2 x .162)	1	16d com (3 1/2 x .162)	1 3 x .120			
	@ 16" o.c.		@ 16" o.c.		@ 16" o.c.		@ 16" o.c.					
	1 3 x .131		1 3 x .131		1 3 x .131		1 3 x .131					
	1 10d box (3 x .128)		1 10d box (3 x .128)		1 10d box (3 x .128)		1 10d box (3 x .128)					
	Stud-to-stud and abutting studs at intersecting wall corners at braced walls 	IBC Connection 9		IBC Connection 9		IBC Connection 9		IBC Connection 9		@ 16" o.c.		@ 12" o.c.
@ 16" o.c.		@ 16" o.c.		@ 16" o.c.		@ 16" o.c.		1 16d com (3 1/2 x .162)		1 12d com (3 1/4 x .148)		
1		16d com (3 1/2 x .162)	1	16d com (3 1/2 x .162)	1	16d com (3 1/2 x .162)	1	16d com (3 1/2 x .162)	1 10d com (3 x .148)		1 16d box (3 1/2 x .135)	
@ 12" o.c.		@ 12" o.c.		@ 12" o.c.		@ 12" o.c.		1 3 1/4 x .131		1 3 x .131		
1		16d box (3 1/2 x .135)	1	16d box (3 1/2 x .135)	1	16d box (3 1/2 x .135)	1	16d box (3 1/2 x .135)	1 3 1/4 x .131		1 3 x .131	
1		3 x .131	1	3 x .131	1	3 x .131	1	3 x .131	@ 8" o.c.		1 3 1/4 x .120	
IRC Connection 9		IRC Connection 9		IRC Connection 9		IRC Connection 9		1 3 x .120		1 3 x .120		
@ 16" o.c.		@ 16" o.c.		@ 16" o.c.		@ 16" o.c.						
1		16d com (3 1/2 x .162)	1	16d com (3 1/2 x .162)	1	16d com (3 1/2 x .162)	1	16d com (3 1/2 x .162)				
@ 12" o.c.		@ 12" o.c.		@ 12" o.c.		@ 12" o.c.						
1		16d box (3 1/2 x .135)	1	16d box (3 1/2 x .135)	1	16d box (3 1/2 x .135)	1	16d box (3 1/2 x .135)				
1		3 x .131	1	3 x .131	1	3 x .131	1	3 x .131				
Abutting studs at corners and intersections not at braced walls 	IBC Connection 23		IBC Connection 8		IBC Connection 8		IBC Connection 8		@ 12" o.c.		@ 8" o.c.	
	@ 24" o.c.		@ 24" o.c.		@ 24" o.c.		@ 24" o.c.		1 16d com (3 1/2 x .162)		1 3 1/4 x .131	
	1	16d com (3 1/2 x .162)	1	16d com (3 1/2 x .162)	1	16d com (3 1/2 x .162)	1	16d com (3 1/2 x .162)	1 12d com (3 1/4 x .148)		1 3 x .131	
	@ 16" o.c.		@ 16" o.c.		@ 16" o.c.		@ 16" o.c.		1 10d com (3 x .148)		1 8d com (2 1/2 x .131)	
	1	3 x .131	1	3 x .131	1	3 x .131	1	3 x .131	1 10d com (3 x .148)		1 3 1/4 x .120	
	IRC Connection 8		IRC Connection 8		IRC Connection 8		IRC Connection 8		1 16d box (3 1/2 x .135)		1 3 x .120	
	@ 16" o.c.		@ 24" o.c.		@ 24" o.c.		@ 24" o.c.					
	1	16d box (3 1/2 x .135)	1	16d com (3 1/2 x .162)	1	16d com (3 1/2 x .162)	1	16d com (3 1/2 x .162)				
	@ 16" o.c.		@ 16" o.c.		@ 16" o.c.		@ 16" o.c.					
	1 3 x .131		1 3 x .131		1 3 x .131		1 3 x .131					
	1 10d box (3 x .128)		1 10d box (3 x .128)		1 10d box (3 x .128)		1 10d box (3 x .128)					

¹Nails must be bright or galvanized carbon steel. Connections using nails of other material, such as stainless steel, must be addressed in an engineered design in accordance with IBC Chapter 16.

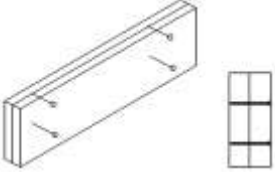
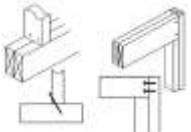
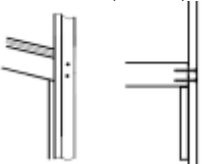
TABLE 11—FASTENING SCHEDULE—WALL FRAMING (cont.)

CONNECTION DESCRIPTION	MINIMUM FASTENING REQUIREMENTS PRESCRIBED IN THE CODE								ALTERNATIVE FASTENING REQUIREMENTS					
	2012 IBC Table 2304.9.1		2015 IBC Table 2304.10.1		2018 IBC Table 2304.10.1		2021 IBC ⁽¹⁾ Table 2304.10.2		All nails are carbon steel. ⁽¹⁾					
	2012 IRC Table R602.3(1)		2015 IRC Table R602.3(1)		2018 IRC Table R602.3(1)		2021 IRC ⁽¹⁾ Table R602.3(1)							
#	Nail Size [Type (inch)]	#	Nail Size [Type (inch)]	#	Nail Size [Type (inch)]	#	Nail Size [Type (inch)]	#	Nail Size [Type (inch)]	#	Nail Size [Type (inch)]			
Built-up header 2-by to 2-by (with or without 1/2" spacer) 	IBC Connection 14		IBC Connection 10		IBC Connection 10		IBC Connection 10		@ 12" o.c. along each edge		@ 8" o.c. along each edge			
	@ 16" o.c. along each edge		@ 16" o.c. along each edge		@ 16" o.c. along each edge		@ 16" o.c. along each edge							
	1	16d com (3 1/2 x .162)	1	16d com (3 1/2 x .162)	1	16d com (3 1/2 x .162)	1	16d com (3 1/2 x .162)	1	16d com (3 1/2 x .162)	1	12d com (3 1/4 x .148)		
	@ 12" o.c.		@ 12" o.c.		@ 12" o.c.		@ 12" o.c.		1	16d box (3 1/2 x .135)	1	10d com (3 x .148)		
	IRC Connection 9		IRC Connection 10		IRC Connection 10		IRC Connection 10							
	@ 16" o.c. along each edge		@ 16" o.c. along each edge		@ 16" o.c. along each edge		@ 16" o.c. along each edge							
	1	16d box (3 1/2 x .135)	1	16d com (3 1/2 x .162)	1	16d com (3 1/2 x .162)	1	16d com (3 1/2 x .162)						
	@ 12" o.c.		@ 12" o.c.		@ 12" o.c.		@ 12" o.c.							
	1	16d box (3 1/2 x .135)	1	16d box (3 1/2 x .135)	1	16d box (3 1/2 x .135)	1	16d box (3 1/2 x .135)						
Continuous header to stud (toe-nail) 	IBC Connection 16		IBC Connection 11		IBC Connection 11		IBC Connection 11		3	16d com (3 1/2 x .162)	5	3 1/4 x .120		
	4	8d com (2 1/2 x .131)	4	8d com (2 1/2 x .131)	4	8d com (2 1/2 x .131)	4	8d com (2 1/2 x .131)	4	12d com (3 1/4 x .148)	5	3 x .120		
			4	10d box (3 x .128)	4	10d box (3 x .128)	4	10d box (3 x .128)	4	10d com (3 x .148)	6	8d box (2 1/2 x .113)		
									5	8d box (2 1/2 x .113)	4	16d box (3 1/2 x .135)	6	2 3/8 x .113
	IRC Connection 9		IRC Connection 11		IRC Connection 11		IRC Connection 11							
	5	8d box (2 1/2 x .113)	4	8d com (2 1/2 x .131)	4	8d com (2 1/2 x .131)	4	8d com (2 1/2 x .131)	4	3 1/4 x .131				
			4	10d box (3 x .128)	4	10d box (3 x .128)	4	10d box (3 x .128)	4	3 x .131				
			5	8d box (2 1/2 x .113)	5	8d box (2 1/2 x .113)	5	8d box (2 1/2 x .113)	4	8d com (2 1/2 x .131)				
Adjacent full-height stud to end of header (end nail) 							IRC Connection 12		3	16d com (3 1/2 x .162)	4	3 x .131		
									3	16d com (3 1/2 x .162)	4	12d com (3 1/4 x .148)		
									4	16d box (3 1/2 x .135)	4	10d box (3 x .148)		
									4	3 x .131	4	16d box (3 1/2 x .135)		
									4	10d box (3 x .128)	4	3 1/4 x .120		
									4	3 1/4 x .131	5	3 x .120		
Double top plates to each other 	IBC Connection 10a		IBC Connection 12		IBC Connection 12		IBC Connection 1		@ 16" o.c.		@ 8" o.c.			
	@ 16" o.c.		@ 16" o.c.		@ 16" o.c.		@ 16" o.c.							
	1	16d box (3 1/2 x .135)	1	16d com (3 1/2 x .162)	1	16d com (3 1/2 x .162)	1	16d com (3 1/2 x .162)	@ 12" o.c.		1	8d com (2 1/2 x .131)		
	@ 12" o.c.		@ 12" o.c.		@ 12" o.c.		@ 12" o.c.							
	1	3 x .131	1	3 x .131	1	3 x .131	1	3 x .131	1	12d com (3 1/4 x .148)	1	3 x .120		
			1	10d box (3 x .128)	1	10d box (3 x .128)	1	10d box (3 x .128)	1	10d com (3 x .148)				
	IRC Connection 13		IRC Connection 12		IRC Connection 12		IRC Connection 13							
	@ 24" o.c.		@ 16" o.c.		@ 16" o.c.		@ 16" o.c.							
	1	10d box (3 x .128)	1	16d com (3 1/2 x .162)	1	16d com (3 1/2 x .162)	1	16d com (3 1/2 x .162)	1	16d box (3 1/2 x .135)	1	3 1/4 x .131		
			@ 12" o.c.		@ 12" o.c.		@ 12" o.c.							
		1	3 x .131	1	3 x .131	1	3 x .131							
		1	10d box (3 x .128)	1	10d box (3 x .128)	1	10d box (3 x .128)							

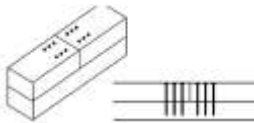

¹Nails must be bright or galvanized carbon steel. Connections using nails of other material, such as stainless steel, must be addressed in an engineered design in accordance with IBC Chapter 16.

TABLE 11—FASTENING SCHEDULE—WALL FRAMING (cont.)

CONNECTION DESCRIPTION	MINIMUM FASTENING REQUIREMENTS PRESCRIBED IN THE CODE								ALTERNATIVE FASTENING REQUIREMENTS				
	2012 IBC Table 2304.9.1		2015 IBC Table 2304.10.1		2018 IBC Table 2304.10.1		2021 IBC ⁽¹⁾ Table 2304.10.2		All nails are carbon steel. ⁽¹⁾				
	2012 IRC Table R602.3(1)		2015 IRC Table R602.3(1)		2018 IRC Table R602.3(1)		2021 IRC ⁽¹⁾ Table R602.3(1)		#	Nail Size [Type (inch)]	#	Nail Size [Type (inch)]	
Top plate to top plate @ end joint (lap splice) 	IBC Connection 10b								IBC Connection 13				
	IBC Connection 13								IBC Connection 13				
	IBC Connection 13								IBC Connection 13				
	Nails each side of joint								Nails each side of joint				
	8	16d com (3 1/2 x .162)	8	16d com (3 1/2 x .162)	8	16d com (3 1/2 x .162)	8	16d com (3 1/2 x .162)	8	16d com (3 1/2 x .162)	12	16d box (3 1/2 x .135)	
	12	3 x .131	12	3 x .131	12	3 x .131	12	16d box (3 1/2 x .135)	12	10d com (3 x .148)	12	3 x .131	
			12	10d box (3 x .128)	12	10d box (3 x .128)	12	3 x .131	For 2015 IRC Connection 13b				
							12	10d box (3 x .128)	10	16d com (3 1/2 x .162)	12	10d com (3 x .148)	
									12	12d com (3 1/4 x .148)	12	16d box (3 1/2 x .135)	
Top plate overlap at corners and intersection 	IBC Connection 13		IBC Connection 18		IBC Connection 17		IBC Connection 17		2	16d com (3 1/2 x .162)	3	3 1/4 x .131	
	2	16d com (3 1/2 x .162)	2	16d com (3 1/2 x .162)	2	16d com (3 1/2 x .162)	2	16d com (3 1/2 x .162)	3	12d com (3 1/4 x .148)	3	3 x .131	
	3	3 x .131	3	3 x .131	3	3 x .131	3	3 x .131	3	10d com (3 x .148)	4	3 1/4 x .120	
			3	10d box (3 x .128)	3	10d box (3 x .128)	3	10d box (3 x .128)	3	16d box (3 1/2 x .135)	4	3 x .120	
	IBC Connection 19		IBC Connection 17		IBC Connection 17		IBC Connection 18						
	2	10d box (3 x .128)	2	16d com (3 1/2 x .162)	2	16d com (3 1/2 x .162)	2	16d com (3 1/2 x .162)					
			3	3 x .131	3	3 x .131	3	3 x .131					
			3	10d box (3 x .128)	3	10d box (3 x .128)	3	10d box (3 x .128)					
	Bottom plate to joist, rim joist or blocking not at braced walls 	IBC Connection 6a		IBC Connection 14		IBC Connection 14		IBC Connection 14		@ 16" o.c.		@ 8" o.c.	
		@ 16" o.c.		@ 16" o.c.		@ 16" o.c.		@ 16" o.c.		1	16d com (3 1/2 x .162)	1	3 1/4 x .120
1		16d box (3 1/2 x .135)	1	16d com (3 1/2 x .162)	1	16d com (3 1/2 x .162)	1	16d com (3 1/2 x .162)		@ 12" o.c.	1	3 x .120	
@ 8" o.c.		@ 12" o.c.		@ 12" o.c.		@ 12" o.c.		1	12d com (3 1/4 x .148)				
1		3 x .131	1	16d box (3 1/2 x .135)	1	16d box (3 1/2 x .135)	1	16d box (3 1/2 x .135)	1	10d com (3 x .148)			
			1	3 x .131	1	3 x .131	1	3 x .131	1	16d box (3 1/2 x .135)			
IBC Connection 15		IBC Connection 14		IBC Connection 14		IBC Connection 15							
@ 16" o.c.		@ 16" o.c.		@ 16" o.c.		@ 16" o.c.		1	3 1/4 x .131				
1		16d box (3 1/2 x .135)	1	16d com (3 1/2 x .162)	1	16d com (3 1/2 x .162)	1	16d com (3 1/2 x .162)	1	3 x .131			
			@ 12" o.c.		@ 12" o.c.		@ 12" o.c.						
		1	16d box (3 1/2 x .135)	1	16d box (3 1/2 x .135)	1	16d box (3 1/2 x .135)						
		1	3 x .131	1	3 x .131	1	3 x .131						

¹Nails must be bright or galvanized carbon steel. Connections using nails of other material, such as stainless steel, must be addressed in an engineered design in accordance with IBC Chapter 16.

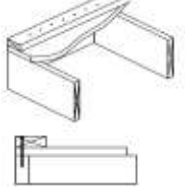
TABLE 11—FASTENING SCHEDULE—WALL FRAMING (cont.)

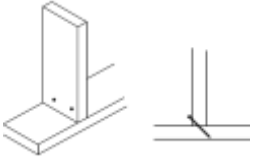
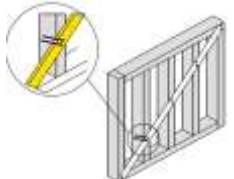
CONNECTION DESCRIPTION	MINIMUM FASTENING REQUIREMENTS PRESCRIBED IN THE CODE								ALTERNATIVE FASTENING REQUIREMENTS			
	2012 IBC Table 2304.9.1		2015 IBC Table 2304.10.1		2018 IBC Table 2304.10.1		2021 IBC ⁽¹⁾ Table 2304.10.2		All nails are carbon steel. ⁽¹⁾			
	2012 IRC Table R602.3(1)		2015 IRC Table R602.3(1)		2018 IRC Table R602.3(1)		2021 IRC ⁽¹⁾ Table R602.3(1)		#	Nail Size [Type (inch)]	#	Nail Size [Type (inch)]
Bottom plate to joist, band joist or blocking at braced walls 	IBC Connection 6b		IBC Connection 15		IBC Connection 15		IBC Connection 15		@ 16" o.c.		@ 12" o.c.	
	@ 16" o.c.		@ 16" o.c.		@ 16" o.c.		@ 16" o.c.		3	12d com (3/4 x .148)	2	16d com (3/2 x .162)
	3	16d box (3/2 x .135)	2	16d com (3/2 x .162)	2	16d com (3/2 x .162)	2	16d com (3/2 x .162)	3	10d com (3 x .148)		
	4	3 x .131	3	16d box (3/2 x .135)	3	16d box (3/2 x .135)	3	16d box (3/2 x .135)	3	16d box (3/2 x .135)		
			4	3 x .131	4	3 x .131	4	3 x .131	4	3/4 x .131		
	IRC Connection 16		IRC Connection 15		IRC Connection 15		IRC Connection 16		4	3 x .131		
	@ 16" o.c.		@ 16" o.c.		@ 16" o.c.		@ 16" o.c.		4	3/4 x .120		
	3	16d box (3/2 x .135)	2	16d com (3/2 x .162)	2	16d com (3/2 x .162)	2	16d com (3/2 x .162)	5	3 x .120		
			3	16d box (3/2 x .135)	3	16d box (3/2 x .135)	3	16d box (3/2 x .135)				
			4	3 x .131	4	3 x .131	4	3 x .131				
Top or bottom plate to stud (face/end nail) 	IBC Connection 7 & 8b		IBC Connection 16b & 17		IBC Connection 16b		IBC Connection 16b		3	16d com (3/2 x .162)	4	3/4 x .131
	2	16d com (3/2 x .162)	2	16d com (3/2 x .162)	2	16d com (3/2 x .162)	2	16d com (3/2 x .162)	3	12d com (3/4 x .148)	4	3 x .131
	3	3 x .131	3	3 x .131	3	3 x .131	3	16d box (3/2 x .135)	3	10d com (3 x .148)	4	8d com (2 1/2 x .131)
			3	10d box (3 x .128)	3	10d box (3 x .128)	3	3 x .131	3	16d box (3/2 x .135)	4	3/4 x .120
							3	10d box (3 x .128)			4	3 x .120
	IRC Connection 18		IRC Connection 16b		IRC Connection 16b		IRC Connection 17b					
	2	16d box (3/2 x .135)	2	16d com (3/2 x .162)	2	16d com (3/2 x .162)	2	16d com (3/2 x .162)				
			3	16d box (3/2 x .135)	3	16d box (3/2 x .135)	3	16d box (3/2 x .135)				
			3	3 x .131	3	3 x .131	3	3 x .131				
			3	10d box (3 x .128)	3	10d box (3 x .128)	3	10d box (3 x .128)				
Stud to top or bottom plate (toe nail) 	IBC Connection 8		IBC Connection 16a		IBC Connection 16a		IBC Connection 16a		3	16d com (3/2 x .162)	4	8d com (2 1/2 x .131)
	4	8d com (2 1/2 x .131)	4	8d com (2 1/2 x .131)	4	8d com (2 1/2 x .131)	3	16d box (3/2 x .135)	4	12d com (3/4 x .148)	5	3/4 x .120
	4	3 x .131	4	3 x .131	4	3 x .131	4	8d com (2 1/2 x .131)	4	10d com (3 x .148)	5	3 x .120
			4	10d box (3 x .128)	4	10d box (3 x .128)	4	3 x .131	4	16d box (3/2 x .135)	6	8d box (2 1/2 x .113)
							4	10d box (3 x .128)	4	3/4 x .131	6	2 3/8 x .113
							4	8d box (2 1/2 x .113)	4	3 x .131	6	6d com (2 x .113)
	IRC Connection 17		IRC Connection 16a		IRC Connection 16a		IRC Connection 17a					
	2	16d box (3/2 x .135)	3	16d box (3/2 x .135)	3	16d box (3/2 x .135)	3	16d box (3/2 x .135)				
	3	8d com (2 1/2 x .131)	4	8d com (2 1/2 x .131)	4	8d com (2 1/2 x .131)	4	8d com (2 1/2 x .131)				
			4	3 x .131	4	3 x .131	4	3 x .131				
		4	10d box (3 x .128)	4	10d box (3 x .128)	4	10d box (3 x .128)					
		4	8d box (2 1/2 x .113)	4	8d box (2 1/2 x .113)	4	8d box (2 1/2 x .113)					
1" Diagonal brace to stud/plate (face-nail) 	IBC Connection 20		IBC Connection 19		IBC Connection 18		IBC Connection 18		2	16d com (3/2 x .162)	2	8d com (2 1/2 x .131)
	2	8d com (2 1/2 x .131)	2	8d com (2 1/2 x .131)	2	8d com (2 1/2 x .131)	2	8d com (2 1/2 x .131)	2	12d com (3/4 x .148)	3	3/4 x .120
	2	3 x .131	2	3 x .131	2	3 x .131	2	3 x .131	2	10d com (3 x .148)	3	3 x .120
			2	10d box (3 x .128)	2	10d box (3 x .128)	2	10d box (3 x .128)	2	16d box (3/2 x .135)	3	8d box (2 1/2 x .113)
							3	8d box (2 1/2 x .113)	2	3/4 x .131	3	2 3/8 x .113
	IRC Connection 20		IRC Connection 18		IRC Connection 18		IRC Connection 19		2	3 x .131	3	2 1/4 x .099
	2	8d box (2 1/2 x .113)	2	8d com (2 1/2 x .131)	2	8d com (2 1/2 x .131)	2	8d com (2 1/2 x .131)				
			2	10d box (3 x .128)	2	10d box (3 x .128)	2	3 x .131				
			3	8d box (2 1/2 x .113)	3	8d box (2 1/2 x .113)	3	10d box (3 x .128)				
							3	8d box (2 1/2 x .113)				

¹Nails must be bright or galvanized carbon steel. Connections using nails of other material, such as stainless steel, must be addressed in an engineered design in accordance with IBC Chapter 16.

TABLE 12—FASTENING SCHEDULE—CEILING AND ROOF FRAMING

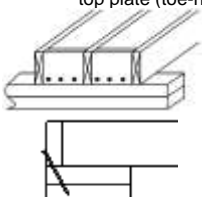
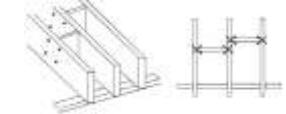
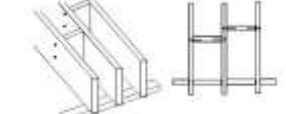
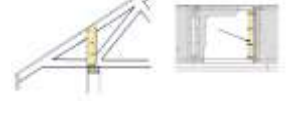
CONNECTION DESCRIPTION	MINIMUM FASTENING REQUIREMENTS PRESCRIBED IN THE CODE								ALTERNATIVE FASTENING REQUIREMENTS			
	2012 IBC Table 2304.9.1		2015 IBC Table 2304.10.1		2018 IBC Table 2304.10.1		2021 IBC ⁽¹⁾ Table 2304.10.2		All nails are carbon steel. ⁽¹⁾			
	2012 IRC Table R602.3(1)		2015 IRC Table R602.3(1)		2018 IRC Table R602.3(1)		2021 IRC ⁽¹⁾ Table R602.3(1)					
#	Nail Size [Type (inch)]	#	Nail Size [Type (inch)]	#	Nail Size [Type (inch)]	#	Nail Size [Type (inch)]	#	Nail Size [Type (inch)]	#	Nail Size [Type (inch)]	
Blocking between joists or rafter to top plate (toe-nail) 	IBC Connection 11		IBC Connection 1a		IBC Connection 1a		IBC Connection 1a		3	16d com (3 1/2 x .162)	3	8d com (2 1/2 x .131)
	3	8d com (2 1/2 x .131)	3	8d com (2 1/2 x .131)	3	8d com (2 1/2 x .131)	3	8d com (2 1/2 x .131)	3	12d com (3 1/4 x .148)	3	10d box (3 x .128)
	3	3 x .131	3	3 x .131	3	3 x .131	3	3 x .131	3	16d box (3 1/2 x .135)	4	3 1/4 x .120
			3	10d box (3 x .128)	3	10d box (3 x .128)	3	10d box (3 x .128)	3	3 1/4 x .131	4	3 x .120
					4	8d box (2 1/2 x .113)	4	8d box (2 1/2 x .113)	3	3 x .131	5	8d box (2 1/2 x .113)
			IRC Connection 1		IRC Connection 1		IRC Connection 1		IRC Connection 1a			
	3	8d box (2 1/2 x .113)	3	8d com (2 1/2 x .131)	3	8d com (2 1/2 x .131)	3	8d com (2 1/2 x .131)				
			3	3 x .131	3	3 x .131	3	3 x .131				
			3	10d box (3 x .128)	3	10d box (3 x .128)	3	10d box (3 x .128)				
			4	8d box (2 1/2 x .113)	4	8d box (2 1/2 x .113)	4	8d box (2 1/2 x .113)				
Blocking between rafters or truss not at wall top plate, to rafter or truss (toe-nail) 			IBC Connection 1b-1		IBC Connection 1b-1		IBC Connection 1b-1		2	16d com (3 1/2 x .162)	2	16d box (3 1/2 x .135)
	2	8d com (2 1/2 x .131)	2	8d com (2 1/2 x .131)	2	8d com (2 1/2 x .131)	2	8d com (2 1/2 x .131)	2	12d com (3 1/4 x .148)	2	3 1/4 x .131
	2	3 x .131	2	3 x .131	2	3 x .131	2	3 x .131	2	10d com (3 x .148)	2	8d com (2 1/2 x .131)
					IRC Connection 1b-1							
					2	8d com (2 1/2 x .131)						
					2	3 x .131						
Blocking between rafters or truss not at wall top plates, to rafter or truss (end nail) 			IBC Connection 1b-2		IBC Connection 1b-2		IBC Connection 1b-2		2	16d com (3 1/2 x .162)	3	3 1/4 x .131
	2	16d com (3 1/2 x .162)	2	16d com (3 1/2 x .162)	2	16d com (3 1/2 x .162)	2	16d com (3 1/2 x .162)	3	12d com (3 1/4 x .148)	3	3 x .131
	3	3 x .131	3	3 x .131	3	3 x .131	3	3 x .131	3	10d com (3 x .148)	4	3 1/4 x .120
					IRC Connection 1b				3	16d box (3 1/2 x .135)	4	3 x .120
					2	16d com (3 1/2 x .162)						
					3	3 x .131						
Flat blocking to truss and web filler (face nail) 			IBC Connection 1c		IBC Connection 1c		IBC Connection 1c		@ 6" o.c.			
	@ 6" o.c.		@ 6" o.c.		@ 6" o.c.		@ 6" o.c.		1	16d com (3 1/2 x .162)	1	16d box (3 1/2 x .135)
	1	16d com (3 1/2 x .162)	1	16d com (3 1/2 x .162)	1	16d com (3 1/2 x .162)	1	16d com (3 1/2 x .162)	1	12d com (3 1/4 x .148)	1	3 1/4 x .131
	1	3 x .131	1	3 x .131	1	3 x .131	1	3 x .131	1	10d com (3 x .148)	1	3 x .131
					IRC Connection 1c							
					@ 6" o.c.							

¹Nails must be bright or galvanized carbon steel. Connections using nails of other material, such as stainless steel, must be addressed in an engineered design in accordance with IBC Chapter 16.

TABLE 12—FASTENING SCHEDULE—CEILING AND ROOF FRAMING (cont.)

CONNECTION DESCRIPTION	MINIMUM FASTENING REQUIREMENTS PRESCRIBED IN THE CODE								ALTERNATIVE FASTENING REQUIREMENTS			
	2012 IBC Table 2304.9.1		2015 IBC Table 2304.10.1		2018 IBC Table 2304.10.1		2021 IBC ⁽¹⁾ Table 2304.10.2		All nails are carbon steel. ⁽¹⁾			
	2012 IRC Table R602.3(1)		2015 IRC Table R602.3(1)		2018 IRC Table R602.3(1)		2021 IRC ⁽¹⁾ Table R602.3(1)					
#	Nail Size [Type (inch)]	#	Nail Size [Type (inch)]	#	Nail Size [Type (inch)]	#	Nail Size [Type (inch)]	#	Nail Size [Type (inch)]	#	Nail Size [Type (inch)]	
Ceiling joist to plate (toe-nail) nail thru each side 	IBC Connection 15		IBC Connection 2		IBC Connection 2		IBC Connection 2		3	16d com (3/2 x .162)	4	3/4 x .120
	3	8d com (2 1/2 x .131)	3	8d com (2 1/2 x .131)	3	8d com 2 1/2 x .131	3	8d com (2 1/2 x .131)	3	12d com (3/4 x .148)	4	3 x .120
	5	3 x .131	3	3 x .131	3	3 x .131	3	3 x .131	3	10d com (3 x .148)	5	8d box (2 1/2 x .113)
			3	10d box (3 x .128)	3	10d box 3 x .128	3	10d box (3 x .128)	3	16d box (3 1/2 x .135)	5	2 3/8 x .113
							4	8d box (2 1/2 x .113)	3	3 1/4 x .131	5	6d com (2 x .113)
	IRC Connection 2		IRC Connection 2		IRC Connection 2		IRC Connection 2		3	3 x .131		
	3	8d box (2 1/2 x .113)	3	8d com (2 1/2 x .131)	3	8d com (2 1/2 x .131)	3	8d com (2 1/2 x .131)	3	8d com (2 1/2 x .131)		
			3	3 x .131	3	3 x .131	3	3 x .131				
			3	10d box (3 x .128)	3	10d box (3 x .128)	3	10d box (3 x .128)				
			4	8d box (2 1/2 x .113)	4	8d box (2 1/2 x .113)	4	8d box (2 1/2 x .113)				
Ceiling joist (not connected to parallel rafter - no thrust), laps over partition 	IBC Connection 17		IBC Connection 3		IBC Connection 3		IBC Connection 3		3	16d com (3/2 x .162)	4	3/4 x .131
	3	16d com (3/2 x .162)	3	16d com (3/2 x .162)	3	16d com (3/2 x .162)	3	16d com (3/2 x .162)	4	12d com (3/4 x .148)	4	3 x .131
	4	3 x .131	4	3 x .131	4	3 x .131	4	3 x .131	4	10d com (3 x .148)	5	3/4 x .120
			4	10d box (3 x .128)	4	10d box (3 x .128)	4	10d box (3 x .128)	4	16d box (3 1/2 x .135)	5	3 x .120
	IRC Connection 3		IRC Connection 3		IRC Connection 3		IRC Connection 3					
	3	10d box (3 x .128)	3	16d com (3/2 x .162)	3	16d com (3/2 x .162)	3	16d com (3/2 x .162)				
			4	3 x .131	4	3 x .131	4	3 x .131				
			4	10d box (3 x .128)	4	10d box (3 x .128)	4	10d box (3 x .128)				
Collar tie to rafter 	IBC Connection 26		IBC Connection 5		IBC Connection 5		IBC Connection 5		3	16d com (3/2 x .162)	4	3 x .131
	3	10d com (3 x .148)	3	10d com (3 x .148)	3	10d com (3 x .148)	3	10d com (3 x .148)	3	12d com (3/4 x .148)	5	8d com (2 1/2 x .131)
	4	3 x .131	4	3 x .131	4	3 x .131	4	3 x .131	3	10d com (3 x .148)	5	3/4 x .120
			4	10d box (3 x .128)	4	10d box (3 x .128)	4	10d box (3 x .128)	4	16d box (3 1/2 x .135)	5	3 x .120
	IRC Connection 4		IRC Connection 5		IRC Connection 5		IRC Connection 5		4	3/4 x .131	6	8d box (2 1/2 x .113)
	3	10d box (3 x .128)	3	10d com (3 x .148)	3	10d com (3 x .148)	3	10d com (3 x .148)				
			4	3 x .131	4	3 x .131	4	3 x .131				
			4	10d box (3 x .128)	4	10d box (3 x .128)	4	10d box (3 x .128)				
Roof rafter or truss to plate, toenail, half each side 	IBC Connection 19		IBC Connection 6		IBC Connection 6		IBC Connection 6		3	16d com (3/2 x .162)	4	3 x .131
	3	8d com (2 1/2 x .131)	3	10d com (3 x .148)	3	10d com (3 x .148)	3	10d com (3 x .148)	3	12d com (3/4 x .148)	4	8d com (2 1/2 x .131)
	3	3 x .131	3	16d box (3 1/2 x .135)	3	16d box (3 1/2 x .135)	3	16d box (3 1/2 x .135)	3	10d com (3 x .148)	4	3/4 x .120
		+ connectors per IBC Section 2308.10.1	4	3 x .131	4	3 x .131	3	3 x .131	3	16d box (3 1/2 x .135)	4	3 x .120
			4	10d box (3 x .128)	4	10d box (3 x .128)	4	10d box (3 x .128)	4	10d box (3 x .128)		
				+ connectors per IBC Section 2308.7.5		+ connectors per IBC Section 2308.7.5		+ connectors per IBC Section 2308.7.5		+ connectors per applicable IBC Section		
	IRC Connection 5		IRC Connection 6		IRC Connection 6		IRC Connection 6					
	3	10d com (3 x .148)	3	10d com (3 x .148)	3	10d com (3 x .148)	3	10d com (3 x .148)				
	3	16d box (3 1/2 x .135)	3	16d box (3 1/2 x .135)	3	16d box (3 1/2 x .135)	3	16d box (3 1/2 x .135)				
			4	3 x .131	4	3 x .131	4	3 x .131				
		4	10d box (3 x .128)	4	10d box (3 x .128)	4	10d box (3 x .128)					

¹Nails must be bright or galvanized carbon steel. Connections using nails of other material, such as stainless steel, must be addressed in an engineered design in accordance with IBC Chapter 16.

TABLE 12—FASTENING SCHEDULE—CEILING AND ROOF FRAMING (cont.)

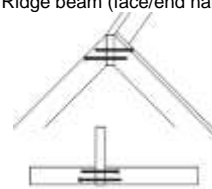
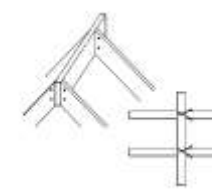
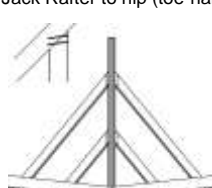
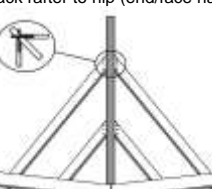
CONNECTION DESCRIPTION	MINIMUM FASTENING REQUIREMENTS PRESCRIBED IN THE CODE								ALTERNATIVE FASTENING REQUIREMENTS			
	2012 IBC Table 2304.9.1		2015 IBC Table 2304.10.1		2018 IBC Table 2304.10.1		2021 IBC ⁽¹⁾ Table 2304.10.2		All nails are carbon steel. ⁽¹⁾			
	2012 IRC Table R602.3(1)		2015 IRC Table R602.3(1)		2018 IRC Table R602.3(1)		2021 IRC ⁽¹⁾ Table R602.3(1)					
#	Nail Size [Type (inch)]	#	Nail Size [Type (inch)]	#	Nail Size [Type (inch)]	#	Nail Size [Type (inch)]	#	Nail Size [Type (inch)]	#	Nail Size [Type (inch)]	
Ridge beam (face/end nail) 	IBC Connection 28b		IBC Connection 7a		IBC Connection 7a		IBC Connection 7a		3	16d com (3 1/2 x .162)	4	3 1/4 x .131
	2	16d com (3 1/2 x .162)	2	16d com (3 1/2 x .162)	2	16d com (3 1/2 x .162)	2	16d com (3 1/2 x .162)	4	12d com (3 1/4 x .148)	4	3 x .131
	3	3 x .131	3	3 x .131	3	3 x .131	3	16d box (3 1/2 x .135)	4	10d com (3 x .148)	5	3 1/4 x .120
			3	10d box (3 x .128)	3	10d box (3 x .128)	3	10d box (3 x .128)	4	16d box (3 1/2 x .135)	5	3 x .120
			IRC Connection 6		IRC Connection 7b		IRC Connection 7b					
	4	16d box (3 1/2 x .135)	2	16d com (3 1/2 x .162)	2	16d com (3 1/2 x .162)	2	16d com (3 1/2 x .162)				
			3	16d box (3 1/2 x .135)	3	16d box (3 1/2 x .135)	3	16d box (3 1/2 x .135)				
			3	3 x .131	3	3 x .131	3	3 x .131				
			3	10d box (3 x .128)	3	10d box (3 x .128)	3	10d box (3 x .128)				
Roof rafter to 2-by ridge beam (toe-nail) 	IBC Connection 28a		IBC Connection 7b		IBC Connection 7b		IBC Connection 7b		3	16d com (3 1/2 x .162)	5	8d com (2 1/2 x .131)
	2	16d com (3 1/2 x .162)	3	10d com (3 x .148)	3	10d com (3 x .148)	3	10d com (3 x .148)	4	12d com (3 1/4 x .148)	6	3 1/4 x .120
	3	3 x .131	3	16d box (3 1/2 x .135)	4	16d box (3 1/2 x .135)	4	16d box (3 1/2 x .135)	4	10d com (3 x .148)	6	3 x .120
			4	3 x .131	4	3 x .131	4	3 x .131	4	16d box (3 1/2 x .135)	6	8d box (2 1/2 x .113)
			4	10d box (3 x .128)	4	10d box (3 x .128)	4	10d box (3 x .128)	5	3 1/4 x .131	6	2 7/8 x .113
			IRC Connection 6		IRC Connection 7a		IRC Connection 7a					
	4	16d box (3 1/2 x .135)	3	10d com (3 x .148)	3	10d com (3 x .148)	3	10d com (3 x .148)				
			4	16d box (3 1/2 x .135)	4	16d box (3 1/2 x .135)	4	16d box (3 1/2 x .135)				
			4	3 x .131	4	3 x .131	4	3 x .131				
			4	10d box (3 x .128)	4	10d box (3 x .128)	4	10d box (3 x .128)				
Jack Rafter to hip (toe-nail) 	IBC Connection 27a		IBC Connection 7b		IBC Connection 7b		IBC Connection 7b		3	16d com (3 1/2 x .162)	5	3 1/4 x .131
	3	10d com (3 x .148)	3	10d com (3 x .148)	3	10d com (3 x .148)	3	10d com (3 x .148)	4	12d com (3 1/4 x .148)	5	3 x .131
	4	3 x .131	3	16d box (3 1/2 x .135)	4	16d box (3 1/2 x .135)	4	16d box (3 1/2 x .135)	4	10d com (3 x .148)	5	8d com (2 1/2 x .131)
			4	3 x .131	4	3 x .131	4	3 x .131	4	16d box (3 1/2 x .135)		
			4	10d box (3 x .128)	4	10d box (3 x .128)	4	10d box (3 x .128)				
			IRC Connection 6		IRC Connection 7a		IRC Connection 7a					
	4	16d box (3 1/2 x .135)	3	10d com (3 x .148)	3	10d com (3 x .148)	3	10d com (3 x .148)				
			4	16d box (3 1/2 x .135)	4	16d box (3 1/2 x .135)	4	16d box (3 1/2 x .135)				
			4	3 x .131	4	3 x .131	4	3 x .131				
			4	10d box (3 x .128)	4	10d box (3 x .128)	4	10d box (3 x .128)				
Jack rafter to hip (end/face nail) 	IBC Connection 27b		IBC Connection 7a		IBC Connection 7a		IBC Connection 7a		3	16d com (3 1/2 x .162)	4	10d com (3 x .148)
	2	16d com (3 1/2 x .162)	2	16d com (3 1/2 x .162)	2	16d com (3 1/2 x .162)	2	16d com (3 1/2 x .162)	4	12d com (3 1/4 x .148)	4	16d box (3 1/2 x .135)
	3	3 x .131	3	3 x .131	3	3 x .131	3	16d box (3 1/2 x .135)				
			3	10d box (3 x .128)	3	10d box (3 x .128)	3	3 x .131				
							3	10d box (3 x .128)				
			IRC Connection 6		IRC Connection 7b		IRC Connection 7b					
	4	16d box (3 1/2 x .135)	2	16d com (3 1/2 x .162)	2	16d com (3 1/2 x .162)	2	16d com (3 1/2 x .162)				
			3	16d box (3 1/2 x .135)	3	16d box (3 1/2 x .135)	3	16d box (3 1/2 x .135)				
			3	3 x .131	3	3 x .131	3	3 x .131				
			3	10d box (3 x .128)	3	10d box (3 x .128)	3	10d box (3 x .128)				

¹Nails must be bright or galvanized carbon steel. Connections using nails of other material, such as stainless steel, must be addressed in an engineered design in accordance with IBC Chapter 16.

TABLE 13—FASTENING SCHEDULE—FLOOR FRAMING

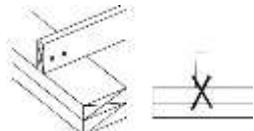
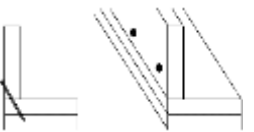
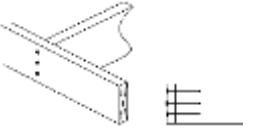
CONNECTION DESCRIPTION	MINIMUM FASTENING REQUIREMENTS PRESCRIBED IN THE CODE								ALTERNATIVE FASTENING REQUIREMENTS					
	2012 IBC Table 2304.9.1		2015 IBC Table 2304.10.1		2018 IBC Table 2304.10.1		2021 IBC ⁽¹⁾ Table 2304.10.2		All nails are carbon steel. ⁽¹⁾					
	2012 IRC Table R602.3(1)		2015 IRC Table R602.3(1)		2018 IRC Table R602.3(1)		2021 IRC ⁽¹⁾ Table R602.3(1)							
	#	Nail Size [Type (inch)]	#	Nail Size [Type (inch)]	#	Nail Size [Type (inch)]	#	Nail Size [Type (inch)]	#	Nail Size [Type (inch)]	#	Nail Size [Type (inch)]		
Joist to sill or girder (toe-nail) nail thru each side 	IBC Connection 1		IBC Connection 22		IBC Connection 21		IBC Connection 21		3	16d com (3/2 x .162)	3	8d com (2/2 x .131)		
	3	8d com (2/2 x .131)	3	8d com (2/2 x .131)	3	8d com (2/2 x .131)	3	8d com (2/2 x .131)	3	12d com (3/4 x .148)	4	3/4 x .120		
	3	3 x .131	3	3 x .131	3	3 x .131	3	3 x .131	3	10d com (3 x .148)	4	3 x .120		
			3	10d box (3 x .128)	3	10d box (3 x .128)	3	10d box (3 x .128)	3	16d box (3/2 x .135)	5	8d box (2/2 x .113)		
							4	8d box (2/2 x .113)	3	3/4 x .131	5	2 3/8 x .113		
			IRC Connection 24		IRC Connection 21		IRC Connection 21		IRC Connection 22		3	3 x .131	5	6d com (2 x .113)
	3	8d box (2/2 x .113)	3	8d com (2/2 x .131)	3	8d com (2/2 x .131)	3	8d com (2/2 x .131)						
			3	3 x .131	3	3 x .131	3	3 x .131						
			3	10d box (3 x .128)	3	10d box (3 x .128)	3	10d box (3 x .128)						
			4	8d box (2/2 x .113)	4	8d box (2/2 x .113)	4	8d box (2/2 x .113)						
Rim joist to top plate (toe-nail) 	IBC Connection 12		IBC Connection 23		IBC Connection 22		IBC Connection 22		@ 6" o.c.		@ 4" o.c.			
	@ 6" o.c.		@ 6" o.c.		@ 6" o.c.		@ 6" o.c.		1	16d com (3/2 x .162)	1	3/4 x .120		
	1	8d com (2/2 x .131)	1	8d com (2/2 x .131)	1	8d com (2/2 x .131)	1	8d com (2/2 x .131)	1	12d com (3/4 x .148)	1	3 x .120		
	1	3 x .131	1	3 x .131	1	3 x .131	1	3 x .131	1	10d com (3 x .148)	1	8d box (2/2 x .113)		
			1	10d box (3 x .128)	1	10d box (3 x .128)	1	10d box (3 x .128)	1	16d box (3/2 x .135)	1	2 3/8 x .113		
							@ 4" o.c.		1	3/4 x .131	@ 3" o.c.			
							1	8d box (2/2 x .113)	1	3 x .131	1	6d com (2 x .113)		
			IRC Connection 25		IRC Connection 22		IRC Connection 22		IRC Connection 23		1	8d com (2/2 x .131)	1	2/4 x .099
			@ 6" o.c.		@ 6" o.c.		@ 6" o.c.		@ 6" o.c.					
	1	8d box (2/2 x .113)	1	8d com (2/2 x .131)	1	8d com (2/2 x .131)	1	8d com (2/2 x .131)	1	8d com (2/2 x .131)				
		1	3 x .131	1	3 x .131	1	3 x .131	1	3 x .131					
		1	10d box (3 x .128)	1	10d box (3 x .128)	1	10d box (3 x .128)	1	10d box (3 x .128)					
		@ 4" o.c.		@ 4" o.c.		@ 4" o.c.		@ 4" o.c.						
		1	8d box (2/2 x .113)	1	8d box (2/2 x .113)	1	8d box (2/2 x .113)	1	8d box (2/2 x .113)					
Joist to band joist (face/end nail) 	IBC Connection 29		IBC Connection 29		IBC Connection 28		IBC Connection 28		3	16d com (3/2 x .162)	4	3/4 x .131		
	3	16d com (3/2 x .162)	3	16d com (3/2 x .162)	3	16d com (3/2 x .162)	3	16d com (3/2 x .162)	4	12d com (3/4 x .148)	4	3 x .131		
	4	3 x .131	4	3 x .131	4	3 x .131	4	3 x .131	4	10d com (3 x .148)	6	3/4 x .120		
			4	10d box (3 x .128)	4	10d box (3 x .128)	4	10d box (3 x .128)	4	16d box (3/2 x .135)	6	3 x .120		
			IRC Connection 26		IRC Connection 26		IRC Connection 27							
			3	16d com (3/2 x .162)	3	16d com (3/2 x .162)	3	16d com (3/2 x .162)						
			4	3 x .131	4	3 x .131	4	3 x .131						
			4	10d box (3 x .128)	4	10d box (3 x .128)	4	10d box (3 x .128)						

¹Nails must be bright or galvanized carbon steel. Connections using nails of other material, such as stainless steel, must be addressed in an engineered design in accordance with IBC Chapter 16.

TABLE 13—FASTENING SCHEDULE—FLOOR FRAMING (cont.)

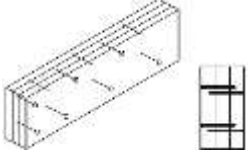
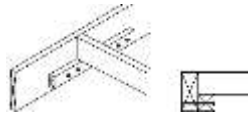
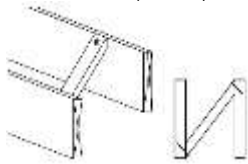
CONNECTION DESCRIPTION	MINIMUM FASTENING REQUIREMENTS PRESCRIBED IN THE CODE				ALTERNATIVE FASTENING REQUIREMENTS																				
	2012 IBC Table 2304.9.1	2015 IBC Table 2304.10.1	2018 IBC Table 2304.10.1	2021 IBC ⁽¹⁾ Table 2304.10.2	All nails are carbon steel. ⁽¹⁾																				
	2012 IRC Table R602.3(1)	2015 IRC Table R602.3(1)	2018 IRC Table R602.3(1)	2021 IRC ⁽¹⁾ Table R602.3(1)	#	Nail Size [Type (inch)]	#	Nail Size [Type (inch)]																	
Built up girder or beam 	IBC Connection 24				IBC Connection 27				IBC Connection 26				IBC Connection 26				face nail at top and bottom, staggered on opposite sides								
	face nail at top and bottom, staggered on opposite sides								@ 32" o.c.																
	@ 32" o.c.				@ 32" o.c.				@ 32" o.c.				@ 32" o.c.				1	20d com (4 x .192)							
	1	20d com (4 x .192)			1	20d com (4 x .192)			1	20d com (4 x .192)			1	20d com (4 x .192)			@ 24" o.c.								
	@ 24" o.c.				@ 24" o.c.				@ 24" o.c.				@ 24" o.c.				1	16d com (3 1/2 x .162)			1	16d box (3 1/2 x .135)			
	1	3 x .131			1	3 x .131			1	3 x .131			1	3 x .131			1	12d com (3 1/4 x .148)			1	3 1/4 x .131			
					1	10d box (3 x .128)			1	10d box (3 x .128)			1	10d box (3 x .128)			1	10d com (3 x .148)			1	3 x .131			
	AND at each end or splice (face nail)								@ 16" o.c.																
	2	20d com (4 x .192)			2	20d com (4 x .192)			2	20d com (4 x .192)			2	20d com (4 x .192)			1	3 1/4 x .120			1	3 x .120			
	3	3 x .131			3	3 x .131			3	3 x .131			3	3 x .131			AND at each end or splice (face nail)								
					3	10d box (3 x .128)			3	10d box (3 x .128)			3	10d box (3 x .128)			2	20d com (4 x .192)			3	16d box (3 1/2 x .135)			
	IRC Connection 30				IRC Connection 27				IRC Connection 27				IRC Connection 28				3	16d com (3 1/2 x .162)			3	3 1/4 x .131			
	face nail at top and bottom staggered on opposite side								@ 16" o.c.																
	1	10d box (3 x .128)			1	20d com (4 x .192)			1	20d com (4 x .192)			1	20d com (4 x .192)			3	10d com (3 x .148)			3	3 1/4 x .120			
					@ 24" o.c.				@ 24" o.c.				@ 24" o.c.												
				1	3 x .131			1	3 x .131			1	3 x .131												
				1	10d box (3 x .128)			1	10d box (3 x .128)			1	10d box (3 x .128)												
AND at each end or splice (face nail)								@ 16" o.c.																	
2	10d box (3 x .128)			2	20d com (4 x .192)			2	20d com (4 x .192)			2	20d com (4 x .192)												
				3	3 x .131			3	3 x .131			3	3 x .131												
				3	10d box (3 x .128)			3	10d box (3 x .128)			3	10d box (3 x .128)												
Ledger strip (face nail) 	IBC Connection 30				IBC Connection 28				IBC Connection 27				IBC Connection 27				3	16d com (3 1/2 x .162)			5	3 x .131			
	3	16d com (3 1/2 x .162)			3	16d com (3 1/2 x .162)			3	16d com (3 1/2 x .162)			3	16d com (3 1/2 x .162)			4	12d com (3 1/4 x .148)			6	8d com (2 1/2 x .131)			
	4	3 x .131			4	3 x .131			4	3 x .131			4	16d box (3 1/2 x .135)			4	10d com (3 x .148)			6	3 1/4 x .120			
					4	10d box (3 x .128)			4	10d box (3 x .128)			4	3 x .131			4	16d box (3 1/2 x .135)			6	3 x .120			
														4	10d box (3 x .128)			5	3 1/4 x .131						
	IRC Connection 31				IRC Connection 28				IRC Connection 28				IRC Connection 29												
	3	16d box (3 1/2 x .135)			3	16d com (3 1/2 x .162)			3	16d com (3 1/2 x .162)			3	16d com (3 1/2 x .162)											
					4	16d box (3 1/2 x .135)			4	16d box (3 1/2 x .135)			4	16d box (3 1/2 x .135)											
					4	3 x .131			4	3 x .131			4	3 x .131											
					4	10d box (3 x .128)			4	10d box (3 x .128)			4	10d box (3 x .128)											
Bridging to joist, rafter or truss each end (toe-nail) 	IBC Connection 2				IBC Connection 30				IBC Connection 29				IBC Connection 29				Nails at each end								
	Nails (total)								Nails at each end								Nails at each end								
	2	8d com (2 1/2 x .131)			2	8d com (2 1/2 x .131)			2	8d com (2 1/2 x .131)			2	8d com (2 1/2 x .131)			2	16d com (3 1/2 x .162)			3	3 1/4 x .120			
	2	3 x .131			2	3 x .131			2	3 x .131			2	3 x .131			2	12d com (3 1/4 x .148)			3	3 x .120			
					2	10d box (3 x .128)			2	10d box (3 x .128)			2	10d box (3 x .128)			2	10d com (3 x .148)			3	8d box (2 1/2 x .113)			
					2	10d box (3 x .128)			2	10d box (3 x .128)			2	10d box (3 x .128)			2	16d box (3 1/2 x .135)			3	2 3/8 x .113			
					IRC Connection 29				IRC Connection 29				IRC Connection 30				2	3 1/4 x .131			3	6d com (2 x .113)			
					2	10d box (3 x .128)			2	8d com (2 1/2 x .131)			2	8d com (2 1/2 x .131)			2	3 x .131			4	2 1/4 x .099			
					2	3 x .131			2	3 x .131			2	3 x .131											
					2	10d box (3 x .128)			2	10d box (3 x .128)			2	10d box (3 x .128)											

¹Nails must be bright or galvanized carbon steel. Connections using nails of other material, such as stainless steel, must be addressed in an engineered design in accordance with IBC Chapter 16.

TABLE 14—SUMMARY OF ALTERNATIVE FASTENING DESIGNS DESCRIBED IN TABLES 11 THROUGH 13^{1,2,3,4}

CONNECTION	NAIL SIZE (DIAMETER X LENGTH) (inches)												
	3 1/2 x 0.162	3 1/4 x 0.148	3 x 0.148	3 1/2 x 0.135	3 1/4 x 0.131	3 x 0.131	2 1/2 x 0.131	3 1/4 x 0.120	3 x 0.120	2 1/2 x 0.113	2 3/8 x 0.113	2 x 0.113	2 1/4 x 0.099
Wall Framing													
Double studs (face nail) Typical	24" o.c.	16" o.c.	16" o.c.	16" o.c.	16" o.c.	16" o.c.	8" o.c.	8" o.c.	8" o.c.				
At braced walls	16" o.c.	12" o.c.	12" o.c.	12" o.c.	12" o.c.	12" o.c.		8" o.c.	8" o.c.				
Abutting studs at corners and intersections Typical	12" o.c.	12" o.c.	12" o.c.	12" o.c.	8" o.c.	8" o.c.	8" o.c.	8" o.c.	8" o.c.				
At braced walls	12" o.c.	12" o.c.	12" o.c.	12" o.c.	12" o.c.	12" o.c.		8" o.c.	8" o.c.				
Built up header 2" to 2" w/ 1/2" spacer	12" o.c.	8" o.c.	8" o.c.	12" o.c.	8" o.c.	8" o.c.		8" o.c.	8" o.c.				
Continuous header to stud (toe nail)	3	4	4	4	4	4	4	5	5	6	6		
Adjacent full-height stud to end of header (toe-nail)	3	4	4	4	4	4		5	5				
Double top plates to each other (face nail)	16" o.c.	12" o.c.	12" o.c.	12" o.c.	12" o.c.	12" o.c.	8" o.c.	8" o.c.	8" o.c.				
Top plate to top plate at end joint (lap splice) (each side of joint)	8	12	12	12	12	12							
For 2015 IRC Connection 13b	10	12	12	12									
Top plate overlap at corners and intersections (face nail)	2	3	3	3	3	3		4	4				
Sole plate to joist or blocking not at braced wall panels	16" o.c.	12" o.c.	12" o.c.	12" o.c.	12" o.c.	12" o.c.		8" o.c.	8" o.c.				
Sole Plate to joist or blocking at braced wall panel	2 @ 16" o.c.	3 @ 16" o.c.	3 @ 16" o.c.	3 @ 16" o.c.	4 @ 16" o.c.	4 @ 16" o.c.		4 @ 16" o.c.	5 @ 16" o.c.				
Top or sole plate to stud (end nail)	3	3	3	3	4	4	4	4	4				
Stud to top or sole plate (toe-nail)	3	4	4	4	4	4	4	5	5	6	6	6	
Diagonal bracing to stud/plate	2	2	2	2	2	2	2	3	3	3	3		4
Ceiling and Roof Framing													
Blocking between joists or Rafter to Top Plate (toe-nail) (each end)	3	3	3	3	3	3	3	4	4	5			
Blocking between rafters or truss, not at wall top plate (toe-nail)	2	2	2	2	2	2	2						
Blocking between rafter or truss, not at wall top plate (end nail)	2	3	3	3	3	3		4	4				
Flat blocking to truss and web filler – face nail	1 @ 6" o.c.	1 @ 6" o.c.	1 @ 6" o.c.	1 @ 6" o.c.	1 @ 6" o.c.	1 @ 6" o.c.							
Ceiling joist to plate ⁵	3	3	3	3	3	3	3	4	4	5	5	5	
Ceiling joists laps over partitions (no thrust)	3	4	4	4	4	4		5	5				
Collar tie to rafter	3	3	3	4	4	4	5	5	5	6			
Roof rafter to plate (toe-nail) (+ connectors per IBC)	3	3	3	3	4	4	4	4	4				
Roof rafter to 2-by ridge beam (end-nail rafter to beam)	3	4	4	4	4	4		5	5				
Roof rafter to 2-by ridge beam (toe-nail rafter to beam)	3	4	4	4	5	5	5	6	6	6	6	6	
Jack rafter to hip (toe-nail)	3	4	4	4	5	5	5						
Jack rafter to hip (end nail)	3	4	4	4									
Floor Framing													
Joist to sill or girder (toe-nail)	3	3	3	3	3	3	3	4	4	5	5	5	
Rim joist to top plate (Toe-nail)	6" o.c.	6" o.c.	6" o.c.	6" o.c.	6" o.c.	6" o.c.	6" o.c.	4" o.c.	4" o.c.	4" o.c.	4" o.c.	3" o.c.	3" o.c.
Joist to band Joist (face nail)	3	4	4	4	4	4		6	6				
Built-up girders & beams Face-nail @ top and bottom PLUS # at ends or splice	24" o.c.	24" o.c.	24" o.c.	24" o.c.	24" o.c.	24" o.c.		16" o.c.	16" o.c.				
Ledger Strip	3	3	3	3	3	3		3	4				
Bridging to Joist (toe-nail)	3	4	4	4	5	5	6	6	6				
	2	2	2	2	2	2	2	3	3	3	3	3	4

For SI: 1 inch = 25.4 mm

¹Alternative fastening requirements shown in this table have been evaluated as alternatives to the IBC and IRC. They can be used under earlier editions of the IBC and IRC where the prescriptive fastening requirements are no worse than those shown in the [Tables 11](#) through [13](#).

²This fastening schedule applies to framing members having an actual thickness of 1 1/2" (nominal "2-by" lumber).

³Fastening schedule only applies to buildings of conventional wood frame construction where wind or seismic analysis is not required by the applicable code. In areas where wind or seismic analysis is required, required fastening must be determined by structural analysis.

⁴Nails may be carbon steel (bright or galvanized).

APPENDIX A—REFERENCE DESIGN INFORMATION

A1.0 Reference Design Values for Nailed Connections:

The information in this section is applicable to the nails listed in [Appendix B](#) of this report.

A1.1 Source:

The equations shown here for nailed connections are found in the 2018, 2015 and 2012 ANSI/AWC National Design Specification (NDS) for Wood Construction.

A1.2 Reference Lateral Design Values:

Reference lateral design values are based on the yielding of connections as wood fibers are crushed and/or fastener shanks are bent. Reference lateral design values are determined from the lowest resulting value from six yield limit equations. These equations and depictions of these yield modes are shown below:

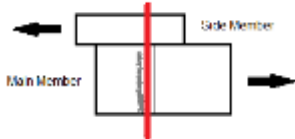
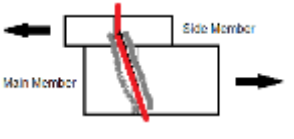
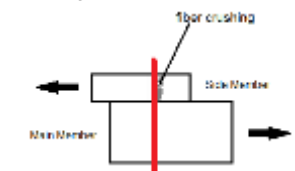
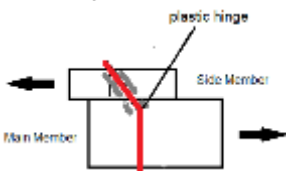
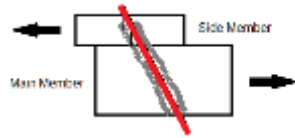
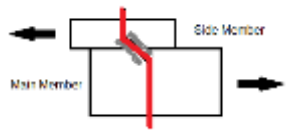
<p>For Mode I_m</p>  $Z = \frac{Dl_m F_{em}}{R_d}$	<p>For Mode III_m</p>  $Z = \frac{k_2 D l_m F_{em}}{(1 + 2R_e) R_d}$
<p>For Mode I_s</p>  $Z = \frac{Dl_s F_{es}}{R_d}$	<p>For Mode III_s</p>  $Z = \frac{k_3 D l_s F_{es}}{(2 + R_e) R_d}$
<p>For Mode II</p>  $Z = \frac{k_1 D l_s F_{es}}{R_d}$	<p>For Mode IV</p>  $Z = \frac{D^2}{R_d} \sqrt{\frac{2F_{em} F_{yb}}{3(1 + R_e)}}$

where:

$$K_1 = \frac{\sqrt{R_e + 2R_e^2(1 + R_i + R_i^2) + R_i^2 R_e^3} - R_e(1 + R_i)}{(1 + R_e)}$$

$$K_2 = -1 + \sqrt{2(1 + R_e) + \frac{2F_{yb}(1 + 2R_e)D^2}{3F_{em}l_m^2}}$$

$$K_3 = -1 + \sqrt{\frac{2(1 + R_e)}{R_e} + \frac{2F_{yb}(2 + R_e)D^2}{3F_{em}l_s^2}}$$

- Z = Reference lateral design value, lbf
- R_e = F_{em} / F_{es}
- l_m = Length of nail in main member (member holding point), inches
- l_s = Length of nail in side member, inches
- F_{em} = Dowel bearing strength of main member (member holding point), psi [See 2018 and 2015 NDS Table 12.3.3 (2012 NDS Table 11.3.3)]
- F_{es} = Dowel bearing strength of side member, psi [See 2018 and 2015 NDS Table 12.3.3 (2012 NDS Table 11.3.3)]
- F_{yb} = Bending yield strength of nail, psi (see [Appendix B](#))
- D = Nominal nail diameter, inch (see [Appendix B](#))
- R_d = 2.2 for $D \leq 0.17"$, 10D + 0.5 for $0.17 < D < 0.25$
- R_t = l_m / l_s

A1.3 Reference Withdrawal Design Values:

A1.3.1 Smooth or Deformed Shank, Carbon Steel (Bright or Galvanized) Nails:

The reference withdrawal design value per unit length of penetration of a smooth or deformed shank, carbon steel nail driven into the side grain (perpendicular to the fiber) of the wood is calculated as follows:

$$W = 1380 G^{5/2} D \tag{Eq. A1.3.1}$$

Where:

- W = Nail reference withdrawal design value in pounds-force per lineal inch of penetration into the member holding the nail point.
- D = Nominal diameter of the nail shank in inches, for $0.092 \leq D \leq 0.375$.
- G = The assigned specific gravity of the wood found in [Table A](#) or the tables indicated below, as applicable:

$$\text{For SI: } W = 9.515 G^{5/2} D \tag{Eq. A1.3.2}$$

Where:

- W = Nail reference withdrawal design value in Newtons per lineal millimeter of penetration into the member holding the nail point.
- D = Nominal diameter of the nail shank in millimeters, for $2.33 \leq D \leq 9.525$.
- G = The assigned specific gravity of the wood found in [Table A](#) or the tables indicated below, as applicable:

Code	Sawn Lumber	Wood Structural Panels
2021, 2018 and 2015 IBC	2018 and 2015 NDS Table 12.3.3A	2018 and 2015 NDS Table 12.3.3B
2012 IBC	2012 NDS Table 11.3.3A	2012 NDS Table 11.3.3B

A1.3.2 Smooth or Deformed Shank, Stainless Steel Nails:

The reference withdrawal design value per unit length of penetration of a smooth or deformed shank, stainless steel nail driven into the side grain (perpendicular to the fiber) of the wood is calculated as follows:

$$W = 465 G^{3/2} D \tag{Eq. A1.3.3}$$

Where:

- W = Nail reference withdrawal design value in pounds-force per lineal inch of penetration into the member holding the nail point.
- D = Nominal diameter of the nail shank in inches, for $0.092 \leq D \leq 0.375$.
- G = The assigned specific gravity of the wood found in [Table A](#) or the tables referenced in Section A1.3.1, as applicable.

$$\text{For SI: } W = 3.206 G^{3/2} D \tag{Eq. A1.3.4}$$

Where:

- W = Nail reference withdrawal design value in Newtons per lineal millimeter of penetration into the member holding the nail point.
- D = Nominal diameter of the nail shank in millimeters, for $2.33 \leq D \leq 9.525$.
- G = The assigned specific gravity of the wood found in [Table A](#) or the tables referenced in Section A1.3.1, as applicable.

TABLE A—ASSIGNED SPECIFIC GRAVITY AND DOWEL BEARING STRENGTH FOR SELECT WOOD SPECIES

SPECIES	SPECIFIC GRAVITY ¹	DOWEL-BEARING STRENGTH F_p (psi)	
		Nailed Connections	Stapled Connections
Aspen	0.39	2,950	3,850
Balsam Fir	0.36	2,550	3,450
Beech-birch-hickory	0.71	8,850	9,750
Coast Sitka Spruce	0.39	2,950	3,850
Douglas Fir-larch	0.50	4,650	5,550
Douglas Fir-south	0.46	4,000	4,900
Eastern Hemlock	0.41	3,200	4,100
Eastern Hemlock-tamarack	0.41	3,200	4,100
Eastern Hemlock-tamarack (north)	0.47	4,150	5,050
Eastern softwoods	0.36	2,550	3,450
Eastern Spruce	0.41	3,200	4,100
Eastern White Pine	0.36	2,550	3,450
Hem-Fir	0.43	3,500	4,400
Mountain Hemlock	0.47	4,150	5,050
Northern Pine	0.42	3,350	4,250
Northern Species	0.35	2,400	3,300
Northern White Cedar	0.31	1,900	2,800
Ponderosa Pine	0.43	3,500	4,400
Red Oak	0.67	7,950	8,850
Red Pine	0.44	3,650	4,550
Sitka Spruce	0.43	3,500	4,400
Southern Pine	0.55	5,550	6,450
Spruce-Pine-Fir	0.42	3,350	4,250
Western Cedars	0.36	2,550	3,450
Western Cedars (North)	0.35	2,400	3,300
Western Hemlock	0.47	4,150	5,050
Western White Pine	0.40	3,100	4,000
White Oak	0.73	9,300	10,200
Yellow Poplar	0.43	3,500	4,400
WOOD STRUCTURAL PANELS			
Plywood: Structural 1, Marine	0.50	4,650	5,550
Plywood: Other Grades	0.42	3,350	4,250
Oriented Strand Board All Grades	0.50	4,650	5,550

For SI: 1 psi = 6.89 kN/m².

¹Specific gravity based on weight and volume when oven dry.

A2.0 Reference Design Values for Stapled Connections:

A2.1 Source:

The equations shown here for stapled connections are found in the ICC-ES Acceptance Criteria for Staples (AC201) dated March 2020 (editorially revised December 2020).

A2.2 Reference Lateral Design Values:

Reference lateral design values for stapled connections must be determined using the minimum result from the equations shown below. These equations are relevant to wood-to-wood connections and to connections in which steel sheet metal is stapled to wood. The steel side member shall have sufficient thickness to prevent tearing of the steel sheet when loaded. Determination of dowel bearing strength of the sheet metal must consider Section I.2 of Appendix I of the NDS. Reference lateral design values are for normal load duration and must be multiplied by all applicable adjustment factors in accordance with the NDS.

Yield Mode I:

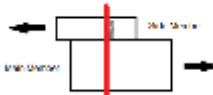

$$Z = \frac{2F_{es}l_s d}{K_D}$$

Yield Mode II:



$$Z = \frac{2dF_{em}}{K_D} \left(\frac{l_m}{1 + \frac{F_{es}}{F_{em}}} \right) \left[\sqrt{\frac{F_{es}}{F_{em}} + 2 \left(\frac{F_{es}}{F_{em}} \right)^2 \left[1 + \frac{l_s}{l_m} + \left(\frac{l_s}{l_m} \right)^2 \right] + \left(\frac{F_{es}}{F_{em}} \right)^3 \left(\frac{l_s}{l_m} \right)^2} - \frac{F_{es}}{F_{em}} \left(1 + \frac{l_s}{l_m} \right) \right]$$

Yield Mode III:

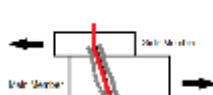

$$Z = \frac{2}{K_D} \left[\frac{-l_s F_{es} d}{2 \frac{F_{es}}{F_{em}} + 1} + F_{es} d \sqrt{\frac{l_s^2}{\left(2 \frac{F_{es}}{F_{em}} + 1 \right)^2} + \frac{l_s^2}{2 \frac{F_{es}}{F_{em}} + 1} + \frac{4M}{F_{es} d \left(2 \frac{F_{es}}{F_{em}} + 1 \right)}} \right]$$

Yield Mode IV:

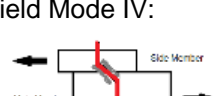

$$Z = \frac{4F_{em} d}{K_D} \sqrt{\frac{M}{F_{em} d \left(1 + \frac{F_{em}}{F_{es}} \right)}}$$

where:

- Z = Reference lateral design value for staple (2 legs), lbf.
- F_{em} = Dowel bearing strength of the main member, psi = 900 psi + F_e from 2018 and 2015 NDS Table 12.3.3 (2012 NDS Table 11.3.3) for D < 1/4"
- F_{es} = Dowel bearing strength of the side member, psi = 900 psi + F_e from 2018 and 2015 NDS Table 12.3.3 (2012 NDS Table 11.3.3) for D < 1/4"
- d = Nominal wire diameter, inch, from [Table 3.2](#).
- M = Minimum staple bending moment, in-lbs., from [Table 3.2](#).
- l_s = Length of staple in side member, inches.
- l_m = Length of staple in main member, inches, (minimum of 12D, where D is the nominal wire diameter from [Table 3.2](#)).
- K_D = Diameter coefficient for staple connections = 2.2

A2.3 Reference Withdrawal Design Values:

The reference withdrawal design value per unit length of penetration of staples driven into the side grain (perpendicular to the fiber) of the wood is calculated as follows:

$$W = 2760 G^{5/2} D \tag{Eq. A1.3.5}$$

where:

- W = Staple reference withdrawal design value, in pounds-force per lineal inch of penetration into the member holding both staple legs.
- G = the assigned specific gravity of the wood (see [Table A](#) and Section A1.3.1).
- D = Nominal wire diameter, in inches, from Table 3.2.

$$\text{For SI: } W = 19.03 G^{5/2} D \tag{Eq. A1.3.6}$$

where:

- W = Staple reference withdrawal design value, in Newtons per linear millimeter of penetration into the member holding both staple legs.
- G = The assigned specific gravity of the wood (see [Table A](#) and Section A1.3.1).
- D = Nominal wire diameter, in millimeters, from Table 3.2.

A3.0 DESIGN INFORMATION FOR DEFLECTION CALCULATIONS FOR DIAPHRAGMS AND SHEAR WALLS

A3.1 NAILS:

To determine the deflection of sheathed diaphragms and shear walls constructed as described in [Tables 6](#) through [10](#), refer to Sections 4.2.3 and 4.3.4 of the 2021 ANSI/AWC Special Design Provisions for Wind and Seismic (SDPWS), respectively (Sections 4.2.2 and 4.3.2 of SDPWS for the 2018, 2015 and 2012 IBC, respectively). For 0.120 inch nails, use the G_a values shown in the SDPWS for the 6d common nails.

A3.2 STAPLES:

The staple deformation values shown in [Table B](#) must be used to determine diaphragm deflection in accordance with the IBC Section 2305.2 or shear wall deflection in accordance with the IBC Section 2305.3, as applicable.

TABLE B—STAPLE DEFORMATION VALUES, e_n , FOR USE IN HORIZONTAL DIAPHRAGM AND SHEAR WALL DEFLECTION ANALYSIS^{1,4}

Staple Gage	16		15		14	
	1½	2	1¾	2½	2	2½
Length (Inches)						
Load Per Fastener ² (Pounds)	Connection Deflection ³ (Inches)					
60	0.008	0.003	0.008	0.005	0.005	0.003
80	0.016	0.006	0.016	0.010	0.011	0.006
100	0.032	0.008	0.028	0.015	0.019	0.009
120	0.055	0.010	0.048	0.025	0.032	0.014
140	0.087	0.024	0.077	0.040	0.050	0.021
160	0.135	0.037	0.118	0.060	0.077	0.031
180	0.205	0.052	0.173	0.088	0.113	0.044
200	—	0.092	0.244	0.127	0.157	0.060
220	—	0.198	0.299	0.178	0.219	0.080
240	—	—	0.346	0.220	0.287	0.097

For SI: 1 inch = 25.4 mm 1 lbf = 4.45 N.

¹Increase deformation value by 20% for plywood grades other than Structural I sheathing.

²Load per fastener is the diaphragm's maximum shear per foot divided by the number of fasteners per foot at interior panel edges.

³Values must be doubled for unseasoned lumber.

⁴Values are for e_n in equations found in the IBC.

APPENDIX B
QUALIFIED FASTENERS BY LISTEE
TABLE B1—LISTEE INFORMATION AND INDEX TO LISTEE PRODUCT DESCRIPTIONS

LISTEE NAME, PRODUCT BRAND NAME(S), AND LISTEE ADDRESS	PAGE NO. FOR THE TABLE WITH LISTEE SPECIFIC PRODUCT DESCRIPTIONS
Aims Leading Industrial Factory (ALIF) P.O. Box 100821, Jeddah – 21311 3 rd Industrial City, Jeddah, Kingdom of Saudi Arabia	35
Beck America, Inc. (Fasco, Fasco/Beck, Beck Fastener Group Brands) 105 Industrial Park Drive Muscle Shoals, Alabama 35661	36
Falcon Fasteners Reg'd 251 Nantucket Boulevard Toronto, Ontario M1P 2P2 CANADA	37
Geekay Wires Ltd. 11-70/5, 2 nd Floor GP Complex Shivalyam Road, Fathenagar Hyderabad 500018 India	38
Huttig Building Products (Huttig-Grip Brand) 555 Maryville University Drive, Suite 400 St. Louis, Missouri 63141	39
Illinois Tool Works (Paslode, Lightning Strike, Duo-Fast Brands) 155 Harlem Avenue Glenview, Illinois 60025	39
Inmax Group	
Inmax Sdn. Bhd. P.T. 6706 Tuanku Jaafar Industry Estate 71450 Seremban, Negeri Sembilan Malaysia	Inmax Industries Sdn. Bhd. Lot 30001 Tuanku Jaafar Industry Estate 71450 Seremban, Negeri Sembilan Malaysia 39
Koki Holdings America Ltd. (Metabo HPT Brand) 1111 Broadway Avenue Braselton, Georgia 30517	40
KYOCERA SENCO Industrial Tools, Inc. (Senco Brand) 8450 Broadwell Road Cincinnati, Ohio 45244	41
Mid-Continent Steel and Wire (Mid-Continent Nail) (Magnum Fasteners Brand) 2700 Central Avenue Poplar Bluff, Missouri 63901	41
National Nail Corp. (ProFit) 2964 Clydon Avenue SW Grand Rapids, MI 49519	42
Oman Fasteners, LLC. Plot No. 5117, Sohar PEIE Industrial Area – Phase 5, PO Box 584 Sohar, Sultanate of Oman, PC322	42
Peace Industries (Spotnails Brand) 1100 Hicks Road Rolling Meadows, Illinois 60008	43
PrimeSource Building Products (Grip-Rite, Fasteners Unlimited, Fits Rite Brands) 1321 Greenway Drive Irving, Texas 75038	44
Shanghai Yueda Nails Co., Ltd.	
Shanghai Yueda Nails Co., Ltd. No.258, Jiangding Road Fengjing Industrial Park, Jinshan District Shanghai 201502 China	YF Technology Corporation (Thailand), Ltd. 223/1 Moo2 Nong-bon daen Sub-District Ban-bun District Chonburi Province, Thailand 45

(Continued on next page)

TABLE B1—LISTEE INFORMATION AND INDEX TO LISTEE PRODUCT DESCRIPTIONS (cont.)

LISTEE NAME, PRODUCT BRAND NAME(S), AND LISTEE ADDRESS	PAGE NO. FOR THE TABLE WITH LISTEE SPECIFIC PRODUCT DESCRIPTIONS
Specialty Fastening Systems, Inc. dba Specialty Nail Co. (Specialty Fasteners, Specialty Nail Brands) 424 South Baggett Prairie Grove, Arkansas 72753	45
Stanley Black and Decker Inc. (BOSTITCH, DEWALT, Craftsman Brands) 701 East Joppa Road Towson, Maryland 21286	46

General Notes for Appendix B:

1. For **SI**: 1 inch = 25.4 mm, 1 psi = 6.89 kPa.
2. For each listee, nails having the diameter, shank type and finish type indicated in the applicable table are qualified for any length. Staples having the indicated diameter and finish are qualified for any leg length greater than 1½ inches.
3. All nails are formed from carbon steel wire, unless designated in the tables below as stainless steel.
4. All nails with diameter of 0.099 inch or greater are qualified for use in framing. Nails with a diameter of 0.092 have only been evaluated for use in tension connections.
5. For a depiction of the various head styles, see [Figure 1](#).

Terminology

LFRA = Lateral force resisting assembly: A diaphragm, shear wall or braced wall.

Head Area Ratio Requirements

The Head Area Ratio (HAR) is the ratio of the difference between the area of the nail head (A_h) and the area of the nail shank (A_s) to the area of the nail head (A_h) as defined in the Acceptance Criteria for Nails (AC116), (A_h - A_s) / A_h

- Y =6d = Meets the HAR requirements for use in sheathing attachment in LFRAs where a 6d common nail is prescribed in the code.
- Y =8d = Meets the HAR requirements for use in sheathing attachment in LFRAs where an 8d common nail is prescribed in the code.
- Y =10d = Meets the HAR requirements for use in sheathing attachment in LFRAs where a 10d common nail is prescribed in the code.
- Y =16d = Meets the HAR requirements for use in sheathing attachment in LFRAs where a 16d common nail is prescribed in the code.
- Y ### = Meets the HAR requirements for a 0.### diameter nail for use in sheathing attachment in shear walls and diaphragms in accordance with [Tables 6](#) through [9](#) of this report.
- N = Not qualified for use in sheathing attachment in LFRAs.
- n/a = Nail size is not prescribed in the code or listed in the diaphragm tables in this report for use in LFRAs. Use of Metal Hardware Nails in LFRAs is outside the scope of this report.

Shank Type

- S = Smooth shank nail
- R = Ring shank nail
- Sc = Screw shank nail

Finish/ Coating Types

- X = The fasteners are carbon steel, "bright" (ungalvanized, uncoated).
- H = Hardened (Bright) = Bending yield strength complies with Table S1.2 of ASTM F1667.
- HT = Bright, heat treated or hardened nail (may be the full nail or only a portion of the nail, such as the tip; compliance with Table S1.2 of F1667 has not been evaluated)
- SS = Stainless Steel
- HDG = Hot-dipped galvanized, complying with ASTM A153 Class D or ASTM A641 Class 3S.
- HHDG = Hardened and hot dip galvanized (Bending yield strength complies with Table S1.2 of ASTM F1667; galvanization complies with ASTM A153 Class D or ASTM A641 Class 3S.)
- HTHDG = Heat Treated or hardened, and hot dip galvanized (Hardening may affect the full nail or only a portion of the nail, such as the tip; nails comply with Table S1.1 of F1667, but compliance with Table S1.2 of F1667 has not been evaluated. Galvanization complies with ASTM A153 Class D.)
- EG = Electrogalvanized, complying with ASTM A641, Class 1.
- HEG = Hardened and electrogalvanized (Bending yield strength complies with Table S1.2 of ASTM F1667; galvanization complies with ASTM A641 Class 1.)
- MG = Mechanically galvanized in accordance with ASTM B695, Class 40.
- P# = Denotes a proprietary coating addressed in an ICC-ES evaluation report, as follows:
P1 = ThickCoat™ addressed in ESR-1482.

AIMS LEADING INDUSTRIAL FACTORY						
NAILS (Brand names: ALIF)						
TYPE OF COLLATION	NOMINAL DIAMETER (inch)	HEAD STYLE	MEETS HEAD AREA RATIO REQUIREMENTS FOR USE IN LFRAs	SHANK TYPE	FINISH/ COATING	SPECIFIED BENDING YIELD STRENGTH, F_{yb} (psi)
Wire	0.099	Full Round	n/a	S, R, Sc	X, HDG, EG	100,000
	0.113		Y = 6d	S, R, Sc	X, HDG, EG	100,000
	0.120		Y 120	S, R, Sc	X, HDG, EG	100,000
	0.131		Y = 8d	S, R, Sc	X, HDG, EG	100,000
	0.135		Y 135	S, R, Sc	X, HDG, EG	100,000
	0.148		Y = 10d	S, R, Sc	X, HDG, EG	90,000
Plastic	0.113	Full Round	Y = 6d	S, R, Sc	X, HDG, EG	100,000
	0.120		Y 120	S, R, Sc	X, HDG, EG	100,000
	0.131		Y = 8d	S, R, Sc	X, HDG, EG	100,000
	0.135		Y 135	S, R, Sc	X, HDG, EG	100,000
	0.148		Y = 10d	S, R, Sc	X, HDG, EG	90,000

BECK AMERICA, INC.						
NAILS (Brand names: FASCO, FASCO/BECK, BECK FASTENER GROUP)						
TYPE OF COLLATION	NOMINAL DIAMETER (inch)	HEAD STYLE	MEETS HEAD AREA RATIO REQUIREMENTS FOR USE IN LFRAs	SHANK TYPE	FINISH/ COATING	SPECIFIED BENDING YIELD STRENGTH, F_{yb} (psi)
Wire, Plastic, Paper	0.092	Full round	n/a	S, R	X, HDG, EG, SS	n/a
				Sc	X, HDG, EG	
	0.099		n/a	S, R	X, HDG, EG, SS	100,000
				Sc	X, HDG, EG	
	0.113		Y =6d	S, Sc	X, HDG, EG	100,000
				R	X, HDG, EG, SS	
	0.120		Y 120	S	X, HDG, EG	100,000
				R, Sc	X, HDG, EG, SS	
	0.131		Y =8d	S	X, HDG, EG	100,000
				R, Sc	X	
0.135	N	S, R, Sc	X	100,000		
0.148	Y =10d	S, R	X, HDG, EG	90,000		
		Sc	X, HDG			
Wire, Plastic	0.162		N	S, Sc	X, HDG	90,000
				R	X	
Plastic	0.180		n/a	S	X	80,000
	0.197		n/a	S	X	80,000
Wire, Plastic, Paper	0.092	Clipped	n/a	S, R	X, HDG, EG, SS	n/a
				Sc	X, HDG, EG	
	0.113		Y =6d	S, Sc	X, HDG, EG	100,000
				R	X, HDG, EG, SS	
	0.120		Y 120	S	X, HDG, EG	100,000
				R, Sc	X, HDG, EG, SS	
0.131	N	S	X, HDG, EG	100,000		
		R, Sc	X			
0.135	N	S, R, Sc	X	100,000		
Wire, Plastic, Paper	0.113	Offset	Y =6d	S, Sc	X, HDG, EG	100,000
				R	X, HDG, EG, SS	
	0.120		N	S	X, HDG, EG	100,000
				R, Sc	X, HDG, EG, SS	
0.135	N	S, R, Sc	X	100,000		
Metal Hardware Nails Designated "Paper Tape joist Hanger Nails" on package labeling						
Paper	0.131	Full Round	n/a	S	X, HDG, EG	100,000
	0.148		n/a	S	X, HDG, EG	90,000
	0.162		n/a	S	X, HDG, EG	90,000
STAPLES (Brand names: FASCO, FASCO/BECK, BECK FASTENER GROUP)						
GAGE		NOMINAL CROWN WIDTH (inch)		FINISH/ COATING		
16		$\frac{7}{16}$		X, EG		
15		$\frac{7}{16}$		X, EG		
14		1		X, EG		

FALCON FASTENERS REG'D							
NAILS							
TYPE OF COLLATION	NOMINAL DIAMETER (inch)	HEAD STYLE	MEETS HEAD AREA RATIO REQUIREMENTS FOR USE IN LFRAs	SHANK TYPE	FINISH/ COATING	SPECIFIED BENDING YIELD STRENGTH, F_{yb} (psi)	
Wire	0.092	Full round	n/a	S, R, Sc	X	n/a	
	0.099		n/a	S	X, HDG, SS, HT, HTHDG	100,000	
				R	X, HDG, SS		
Sc				X, HDG			
Wire, Plastic, Paper	0.113		Y =6d	Y =6d	S	X, HDG, SS, HT, HTHDG	100,000
					R	X, HDG, SS	
					Sc	X, HDG	
	0.120		Y 120	Y 120	S	X, HDG, SS, HT, HTHDG	100,000
					R	X, HDG, SS	
					Sc	X, HDG	
	0.131		Y =8d	Y =8d	S	X, HDG, SS, HT, HTHDG	100,000
					R	X, HDG, SS	
		Sc			X, HDG		
	0.148	Y =10d	Y =10d	S	X, HDG, SS, HT, HTHDG	90,000	
				R	X, HDG, SS		
	0.162	Y =16d	Y =16d	S	X, HDG, HT, HTHDG	90,000	
Wire, Paper	0.113	Notched	Y =6d	S	X, HDG, SS, HT, HTHDG	100,000	
				R	X, HDG, SS		
				Sc	X, HDG		
	0.120		Y 120	Y 120	S	X, HDG, SS, HT, HTHDG	100,000
					R	X, HDG, SS	
					Sc	X, HDG	
	0.131		Y =8d	Y =8d	S	X, HDG, SS, HT, HTHDG	100,000
					R	X, HDG, SS	
					Sc	X, HDG	
Paper	0.113	Clipped	Y =6d	S	X, HDG, SS, HT, HTHDG	100,000	
				R	X, HDG, SS		
				Sc	X, HDG		
	0.120		Y 120	Y 120	S	X, HDG, SS, HT, HTHDG	100,000
					R	X, HDG, SS	
					Sc	X, HDG	
	0.131		Y =8d	Y =8d	S	X, HDG, SS, HT, HTHDG	100,000
					R	X, HDG, SS	
					Sc	X, HDG	
	0.148		Y =10d	Y =10d	S	X, HDG, SS, HT, HTHDG	90,000
					R	X, HDG, SS	
	Wire, Paper		0.113	Offset	Y =6d	S	X, HDG, SS, HT, HTHDG
R		X, HDG, SS					
Sc		X, HDG					
0.120		Y 120	Y 120		S	X, HDG, SS, HT, HTHDG	100,000
					R	X, HDG, SS	
					Sc	X, HDG	
0.131		Y =8d	Y =8d		S	X, HDG, SS, HT, HTHDG	100,000
					R	X, HDG, SS	
					Sc	X, HDG	
Paper	0.148	Y =10d	Y =10d	S	X, HDG, SS, HT, HTHDG	90,000	
				R	X, HDG, SS		
Metal Hardware Nails							
Designated as "Metal Connector Nail" or "Joist Hanger Nail" on package labeling							
Paper	0.131	Full round**	n/a	S	X, HDG, SS, HT, HTHDG	100,000	
				R	X, HDG, SS		
	0.148			S	X, HDG, SS, HT, HTHDG	90,000	
				R	X, HDG, SS		
	0.162			S	X, HDG, HT, HTHDG	90,000	

Head markings for Metal Hardware Nails:

'1' or '8' for 1 1/2 x 0.131; '2' or '8d' for 2 1/2 x 0.131; '3' or '10' for 1 1/2 x 0.148; '4' or '10L' for 2 1/2 x 0.148; '5' or '16' for 2 1/2 x 0.162

GEEKAY WIRES LTD.						
NAILS						
TYPE OF COLLATION	NOMINAL DIAMETER (inch)	HEAD STYLE	MEETS HEAD AREA RATIO REQUIREMENTS FOR USE IN LFRAs	SHANK TYPE	FINISH/ COATING	SPECIFIED BENDING YIELD STRENGTH, F_{yb} (psi)
Wire	0.092	Full round	n/a	S, R, Sc	SS	n/a
Wire, Plastic	0.099		n/a	S, R, Sc	X, HDG, EG	100,000
	0.113		Y =6d	S, R, Sc	X, HDG, EG	100,000
	0.120		Y 120	S, R, Sc	X, HDG, EG	100,000
	0.131		Y =8d	S, R, Sc	X, HDG, EG	100,000
	0.135		Y 135	S, R, Sc	X, HDG, EG	100,000
	0.148		Y =10d	S, R, Sc	X, HDG, EG	90,000
	0.162		Y =16d	S, R, Sc	X, HDG, EG	90,000
	Paper		0.113	Clipped, Offset	Y =6d	S, R, Sc
0.120		Y 120	S, R, Sc		X, HDG, EG	100,000
0.131		Y =8d	S, R, Sc		X, HDG, EG	100,000
Metal Hardware Nails (Designated "Metal Connector Nail" on package labeling)						
Paper	0.131	Full round	n/a	S, R, Sc	X, HDG, EG	100,000
	0.148		n/a	S, R, Sc	X, HDG, EG	90,000
	0.162		n/a	S, R, Sc	X, HDG, EG	90,000

HUTTIG BUILDING PRODUCTS							
NAILS (Brand name: HUTTIG-GRIP)							
TYPE OF COLLATION	NOMINAL DIAMETER (inch)	HEAD STYLE	MEETS HEAD AREA RATIO REQUIREMENTS FOR USE IN LFRAs	SHANK TYPE	FINISH/ COATING	SPECIFIED BENDING YIELD STRENGTH, F_{yb} (psi)	
Wire	0.092	Full round	n/a	S, R, Sc	X, HDG, EG	n/a	
	0.099		n/a	S, R, Sc	X, HDG, EG	100,000	
Wire, Plastic, Paper	0.113		Y =6d	S, R, Sc	X, HDG, EG	100,000	
	0.120		Y 120	S, R, Sc	X, HDG, EG	100,000	
	0.131		Y =8d	S, R, Sc	X, HDG, EG	100,000	
	0.135		Y 135	S, R, Sc	X, HDG, EG	100,000	
	0.148		Y =10d	S, R, Sc	X, HDG, EG	90,000	
Wire, Plastic	0.162		Y =16d	S, R, Sc	X, HDG, EG	90,000	
Wire, Paper	0.113		Clipped	Y =6d	S, R, Sc	X, HDG, EG	100,000
	0.120			Y 120	S, R, Sc	X, HDG, EG	100,000
	0.131	Y =8d		S, R, Sc	X, HDG, EG	100,000	
	0.113	Offset	Y =6d	S, R, Sc	X, HDG, EG	100,000	
			0.120	Y 120	S, R, Sc	X, HDG, EG	100,000
			0.131	Y =8d	S, R, Sc	X, HDG, EG	100,000
Metal Hardware Nails (Designated "Metal Connector Nail" on package labeling)							
Paper	0.131	Full round	n/a	S	H, HHDG, HEG	130,000	
	0.148		n/a	S	H, HHDG, HEG	115,000	
	0.162		n/a	S	H, HHDG, HEG	115,000	
Paper*	0.131	Full round	n/a	S, R, Sc	X, HDG, EG	100,000	
	0.148		n/a	S, R, Sc	X, HDG, EG	90,000	
	0.162		n/a	S, R, Sc	X, HDG, EG	90,000	
Head markings for metal hardware nails: '1' for 1 1/2 x 0.131; '2' for 2 1/2 x 0.131; '3' for 1 1/2 x 0.148; '4' for 2 1/2 x 0.148; '5' for 2 1/2 x 0.162							
*Plastic collation is available for X and HDG nails with smooth shank.							

ILLINOIS TOOL WORKS COMPANY						
NAILS (Brand names: PASLODE, LIGHTNING STRIKE, DUO-FAST)						
TYPE OF COLLATION	NOMINAL DIAMETER (inch)	HEAD STYLE (applicable brand name)	MEETS HEAD AREA RATIO REQUIREMENTS FOR USE IN LFRAs	SHANK TYPE	FINISH/ COATING	SPECIFIED BENDING YIELD STRENGTH, F_{yb} (psi)
Plastic, paper	0.113	Full Round	Y =6d	S, R	X, HDG	100,000
	0.120		Y 120	R, Sc	HDG	100,000
	0.131		Y =8d	S	X, HDG	100,000
			Sc	HDG	100,000	
	0.148		Y =10d	S	X	90,000
Paper	0.113	Offset (RounDrive™)	Y =6d	S, R	X, HDG	100,000
	0.120		Y 120	S, R	X	100,000
	0.135		Y 135	S	X	100,000
Paper	0.113	Clipped (Paslode)	Y =6d	S, R	HDG	100,000
	0.120		Y 120	S, R, Sc	X, HDG	100,000
	0.131		N	S, R	X	100,000

INMAX GROUP – INMAX SDN. BHD. & INMAX INDUSTRIES SDN.BHD.						
NAILS						
TYPE OF COLLATION	NOMINAL DIAMETER (inch)	HEAD STYLE	MEETS HEAD AREA RATIO REQUIREMENTS FOR USE IN LFRAs	SHANK TYPE	FINISH/ COATING	SPECIFIED BENDING YIELD STRENGTH, F_{yb} (psi)
Wire, Plastic	0.113	Full Round	Y =6d	S, R, Sc	X	100,000
	0.120		Y 120	S, R, Sc	X	100,000
	0.131		Y =8d	S, R, Sc	X	100,000
	0.135		Y 135	S	X	100,000
	0.148		Y =10d	S, R, Sc	X	90,000
Plastic	0.162		Y =16d	S	X	90,000

KOKI HOLDINGS AMERICA LTD.								
NAILS (Brand name: METABO-HPT)								
TYPE OF COLLATION	NOMINAL DIAMETER (inch)	HEAD STYLE	MEETS HEAD AREA RATIO REQUIREMENTS FOR USE IN LFRAs	SHANK TYPE	FINISH/ COATING	SPECIFIED BENDING YIELD STRENGTH, F_{yb} (psi)		
Wire	0.092	Full round	n/a	Sc	SS	n/a		
Wire, Plastic, Paper	0.092	Full round	n/a	S, R	X, EG, HDG, SS	n/a		
				Sc	X, EG, HDG			
	0.099		n/a	S, R, Sc	X, EG, HDG	100,000		
	0.113		Y =6d	S	X, EG, HDG, SS, HT	100,000		
				R	X, EG, HDG, SS			
				Sc	X, EG, HDG			
	0.120		Y 120	S	X, EG, HDG, SS, HT	100,000		
				R	X, EG, HDG, SS			
				Sc	X, EG, HDG			
	0.131		Y =8d	S	X, EG, HDG, SS, HT	100,000		
				R	X, EG, HDG, SS			
				Sc	X, HDG			
0.148	Y =10d	S	X, EG, HDG, SS, HT	90,000				
		R	X, EG, HDG, SS					
		Sc	X, HDG					
Wire, Plastic	0.162	Full round	N	S	X, EG, HDG	90,000		
				Y =16d	S	X, EG, HDG	90,000	
				0.131	Y =8d	Sc	EG	100,000
				0.135	Y 135	S, R, Sc	X, EG, HDG	100,000
				0.148	Y =10d	Sc	EG	90,000
Paper	0.162*	Full round	Y =16d	R, Sc	X, EG, HDG	90,000		
				Clipped	Y =6d	S, R, Sc	X, EG, HDG	100,000
					Y 120	S, R, Sc	X, EG, HDG	100,000
Y =8d	S, R, Sc	X, EG, HDG	100,000					
Wire, Paper	0.113	Offset	Y =6d	S, R, Sc	X, EG, HDG	100,000		
				Y 120	S, R, Sc	X, EG, HDG	100,000	
					Y =8d	S, R, Sc	X, EG, HDG	100,000
Metal Hardware Nails								
Designated "Strap-Tite" on package labeling								
Paper	0.131	Full round	n/a	S	H, HHDG, HEG	130,000		
	0.148		n/a	S	H, HHDG, HEG	115,000		
	0.162		n/a	S	H, HHDG, HEG	115,000		

Head markings for metal hardware nails:

'H1' for 1 1/2 x 0.131; 'H2' for 2 1/2 x 0.131; 'H3' for 1 1/2 x 0.148; 'H4' for 2 1/2 x 0.148; 'H5' for 2 1/2 x 0.162

* Nails are manufactured in India.

KYOCERA SENCO INDUSTRIAL TOOLS, INC.						
NAILS (Brand name: SENCO)						
TYPE OF COLLATION	NOMINAL DIAMETER (inch)	HEAD STYLE	MEETS HEAD AREA RATIO REQUIREMENTS FOR USE IN LFRAS	SHANK TYPE	FINISH/ COATING	SPECIFIED BENDING YIELD STRENGTH, F_{yb} (psi)
Wire, Plastic	0.113	Full Round	Y =6d	S, R	X, EG, HDG	100,000
	0.120		Y 120	S, Sc R	X, EG, HDG X, HDG	100,000
Wire, Plastic, Paper	0.131		Y =8d	S R	X, EG, HDG X, HDG	100,000
	0.135		Y 135	S	X	100,000
Plastic, Paper	0.148		Y =10d	S	X, HDG	90,000
Paper	0.162		Y =16d	S	X, HDG, HT	90,000
Paper	0.113	Clipped	Y =6d	S, R S	X, EG, HDG X, EG, HDG	100,000
	0.120		Y 120	R	X, HDG	100,000
	0.131		Y =8d	S R	X, EG, HDG X, HDG	100,000
	0.135		Y 135	S	X, EG, HDG	100,000
Paper	0.113	Offset	Y =6d	S, R	X, HDG	100,000
	0.120		Y 120	S, R	X, HDG	100,000
	0.131		Y =8d	S, R	X, HDG	100,000
Metal Hardware Nails						
Designated "Hardened Metal Connector Nails" on package labeling						
Paper	0.131	Full round	n/a	S	H, HHDG, HEG	130,000
	0.148		n/a	S	H, HHDG, HEG	115,000
	0.162		n/a	S	H, HHDG, HEG	115,000
Designated "Metal Connector Nails" on package labeling						
Paper	0.131	Full round	n/a	S	X, HDG	100,000
	0.148		n/a	S	X, HDG	90,000
	0.162		n/a	S	X, HDG	90,000
STAPLES (Brand name: SENCO)						
GAGE		NOMINAL CROWN WIDTH (inch)		FINISH/ COATING		
14		$\frac{7}{16}$		X		
15		$\frac{7}{16}$		X, EG		
16		$\frac{7}{16}, 1$		X, EG		

MID-CONTINENT STEEL AND WIRE (MID-CONTINENT NAIL)						
NAILS (Brand name: MAGNUM FASTENERS)						
TYPE OF COLLATION	NOMINAL DIAMETER (inch)	HEAD STYLE	MEETS HEAD AREA RATIO REQUIREMENTS FOR USE IN LFRAS	SHANK TYPE	FINISH/ COATING	SPECIFIED BENDING YIELD STRENGTH, F_{yb} (psi)
Wire	0.092	Full Round	n/a	S, R, Sc	X, EG, HDG	n/a
	0.099		n/a	S, R, Sc	X, EG, HDG	100,000
Wire, Plastic, Paper	0.113		Y =6d	S, R, Sc	X, EG, HDG	100,000
	0.120		Y 120	S, R, Sc	X, EG, HDG	100,000
	0.131		Y =8d	S, R, Sc	X, EG, HDG	100,000
Wire, Plastic	0.135		Y 135	S, R, Sc	X, EG, HDG	100,000
	Plastic	0.148	Y =10d	S, R, Sc	X, EG, HDG	90,000
0.162		N	S, R, Sc	X, EG, HDG	90,000	
Paper	0.113	Offset	Y =6d	S, R, Sc	X, HDG	100,000
	0.120		Y 120	S, R, Sc	X, HDG	100,000
	0.131		Y 8d	S, R, Sc	X, HDG	100,000
Metal Hardware Nails						
Designated "Hardware Nails" on package labeling						
Paper	0.131	Full round	n/a	S	X, HDG	100,000
	0.148		n/a	S	X, HDG	90,000
	0.162		n/a	S	X, HDG	90,000

Head markings for metal hardware nails:
 'H' for 1 1/2 x 0.131; 'I' for 2 1/2 x 0.131; 'Q' for 1 1/2 x 0.148; 'U' for 2 1/2 x 0.148; 'X' for 2 1/2 x 0.162

NATIONAL NAIL CORPORATION							
NAILS (Brand name: PROFIT)							
TYPE OF COLLATION	NOMINAL DIAMETER (inch)	HEAD STYLE	MEETS HEAD AREA RATIO REQUIREMENTS FOR USE IN LFRAS	SHANK TYPE	FINISH/ COATING	SPECIFIED BENDING YIELD STRENGTH, F_{yb} (psi)	
Wire	0.092	Full Round	n/a	S, R, Sc	X, HDG, SS	n/a	
	0.099		n/a	S, R, Sc	X, EG, HDG	100,000	
	0.099		n/a	S	H	130,000	
	0.113		Y =6d	S	H	130,000	
Wire, Plastic	0.113		Y =6d	S, R, Sc	X, EG, HDG	100,000	
	0.120		Y 120	S, R, Sc	X, EG, HDG	100,000	
	0.120		Y 120	S, R, Sc	H, HHDG, HEG	130,000	
	0.131		Y =8d	S, R, Sc	X, EG, HDG	100,000	
	0.135		Y 135	S, R, Sc	X, EG, HDG	100,000	
	0.148		Y =10d	S, R, Sc	X, EG, HDG	90,000	
	Wire, Plastic, Paper		0.162	Y =16d	S, R, Sc	X, EG, HDG	90,000
				Y =8d	S, R, Sc	H, HHDG, HEG	130,000
Wire, Paper	0.113		Clipped	Y =6d	S, R, Sc	X, EG, HDG	100,000
	0.120			Y 120	S, R, Sc	X, EG, HDG	100,000
	0.131			Y =8d	S, R, Sc	X, EG, HDG	100,000
Wire, Paper	0.113		Offset	Y =6d	S, R, Sc	X, EG, HDG	100,000
	0.120	Y 120		S, R, Sc	X, EG, HDG	100,000	
	0.131	Y =8d		S, R, Sc	X, EG, HDG	100,000	
Metal Hardware Nails (Designated "Joist Hanger Nail" on package labeling)							
Paper	0.131	Full round	n/a	S, R, Sc	X, HDG, EG	100,000	
	0.148		n/a	S, R, Sc	X, HDG, EG	90,000	
	0.162		n/a	S, R, Sc	X, HDG, EG	90,000	

Head markings for metal hardware nails:
'1' or '8' for 1 1/2 x 0.131; '2' or '8d' for 2 1/2 x 0.131; '3' & '10' for 1 1/2 x 0.148; '4' or '10L' for 2 1/2 x 0.148; '5' or '16' for 2 1/2 x 0.162

OMAN FASTENERS							
NAILS							
TYPE OF COLLATION	NOMINAL DIAMETER (inch)	HEAD STYLE	MEETS HEAD AREA RATIO REQUIREMENTS FOR USE IN LFRAS	SHANK TYPE	FINISH/ COATING	SPECIFIED BENDING YIELD STRENGTH, F_{yb} (psi)	
Wire	0.092	Full Round	n/a	S, R, Sc	X, EG, HDG	n/a	
	0.099		n/a	S, R, Sc	X, EG, HDG	100,000	
Wire, Plastic	0.113		Y =6d	S, R, Sc	X, EG, HDG	100,000	
	0.120		Y 120	S, R, Sc	X, EG, HDG	100,000	
	0.131		Y =8d	S, R, Sc	X, EG, HDG	100,000	
			Y =10d	S, R, Sc	X, EG, HDG	90,000	
Plastic	0.148		Y =16d	S, R, Sc	X, EG, HDG	90,000	
	0.162		Y =6d	S, R, Sc	X, EG, HDG	100,000	
Wire, Paper	0.113		Clipped	Y 120	S, R, Sc	X, EG, HDG	100,000
	0.120			Y =8d	S, R, Sc	X, EG, HDG	100,000
	0.131	Y =6d		S, R, Sc	X, EG, HDG	100,000	
Wire, Paper	0.113	Offset	Y 120	S, R, Sc	X, EG, HDG	100,000	
	0.120		Y =8d	S, R, Sc	X, EG, HDG	100,000	
	0.131		Y =6d	S, R, Sc	X, EG, HDG	100,000	
Metal Hardware Nails (Designated "Hardened Joist Hanger Nail" on package labeling)							
Paper	0.131	Full Round	n/a	S	H, HHDG, HEG	130,000	
	0.148		n/a	S	H, HHDG, HEG	115,000	
	0.162		n/a	S	H, HHDG, HEG	115,000	

Head markings for metal hardware nails:
'1' for 1 1/2 x 0.131; '2' for 2 1/2 x 0.131; '3' for 1 1/2 x 0.148; '4' for 2 1/2 x 0.148; '5' for 2 1/2 x 0.162

STAPLES		
GAGE	NOMINAL CROWN WIDTH (inch)	FINISH / COATING
14	7/16, 1/2, 15/16	EG
15	7/16, 1/2	EG
16	7/16, 1/2, 15/16, 1	EG

PEACE INDUSTRIES						
NAILS (Brand name: SPOTNAILS)						
TYPE OF COLLATION	NOMINAL DIAMETER (inch)	HEAD STYLE	MEETS HEAD AREA RATIO REQUIREMENTS FOR USE IN LFRAs	SHANK TYPE	FINISH/ COATING	SPECIFIED BENDING YIELD STRENGTH, F_{yb} (psi)
Wire	0.092	Full Round	n/a	S, R, Sc	SS	n/a
Wire, Plastic	0.099	Full Round	n/a	S, R, Sc	X, EG, HDG	100,000
	0.113					
	0.120		Y =6d	S, R, Sc	X, EG, HDG	100,000
	0.131		Y 120*	S, R, Sc	X, EG, HDG	100,000
	0.135		Y =8d	S, R, Sc	X, EG, HDG	100,000
	0.148		Y 135	S, R, Sc	X, EG, HDG	100,000
	0.162		Y =10d*	S, R, Sc	X, EG, HDG	90,000
	0.162		Y =16d	S, R, Sc	X, EG, HDG	90,000
Paper	0.113	Clipped, Offset	Y =6d*	S, R, Sc	X, EG, HDG	100,000
	0.120		Y 120*	S, R, Sc	X, EG, HDG	100,000
	0.131		Y= 8d*	S, R, Sc	X, EG, HDG	100,000
Metal Hardware Nails						
(Designated "Joist Hanger Nail" on package labeling)						
Paper	0.131	Full Round	n/a	S, R, Sc	X, HDG, EG	100,000
	0.148			S, R, Sc	X, HDG, EG	90,000
	0.162			S, R, Sc	X, HDG, EG	90,000
(Designated "Joist Hanger Nail High Carbon" on package labeling)						
Wire, Plastic	0.120	Full Round	n/a	S, R, Sc	H, HEG	130,000
	0.131			S, R, Sc	H, HEG	130,000
Paper	0.131			S	H, HHDG, HEG	130,000
	0.148			S	H, HHDG, HEG	115,000
	0.162			S	H, HHDG, HEG	115,000

*Not applicable (n/a) for the nails manufactured in Lithuania.

PRIMESOURCE BUILDING PRODUCTS						
NAILS (Brand names: GRIP-RITE, FAS'NERS UNLIMITED, FITS RITE)						
TYPE OF COLLATION	NOMINAL DIAMETER (inch)	HEAD STYLE	MEETS HEAD AREA RATIO REQUIREMENTS FOR USE IN LFRAs	SHANK TYPE	FINISH/ COATING	SPECIFIED BENDING YIELD STRENGTH, F_{yb} (psi)
Wire	0.092	Full Round	n/a	S, R, Sc	SS	100,000
	0.099		n/a	S, R, Sc	X, HDG, EG	100,000
	0.099		n/a	S	H	130,000
	0.113		Y =6d	S	H	130,000
	0.135		Y 135	S, R, Sc	X, HDG, EG	100,000
	0.148		Y =10d	S R, Sc	X, HDG, EG X	90,000
Wire, Plastic	0.113	Full Round	Y =6d	S, R, Sc	X, HDG, EG	100,000
	0.120		Y 120	S, R, Sc	X, HDG, EG	100,000
	0.120		Y 120	S, R, Sc	H, HHDG, HEG	130,000
	0.131		Y =8d	S, R, Sc	X, HDG, EG	100,000
Wire, Plastic, Paper	0.131	Full Round	Y=8d	S, R, Sc	H. HDHG, HEG	130,000
Plastic	0.135		Y 135	S, R, Sc	X	100,000
	0.148		Y =10d	S, R, Sc	X, HDG, EG	90,000
	0.162		Y =16d	S, R, Sc	X, HDG, EG	90,000
Paper	0.113	Clipped	Y =6d	S, R, Sc	X, HDG, EG	100,000
	0.120		Y 120	S, R, Sc	X, HDG, EG	100,000
	0.131		Y =8d	S, R, Sc	X, HDG, EG	100,000
Paper	0.113	Offset	Y =6d	S, R, Sc	X, HDG, EG	100,000
	0.120		Y 120	S, R, Sc	X, HDG, EG	100,000
	0.131		Y= 8d	S, R, Sc	X, HDG, EG	100,000
Metal Hardware Nails (Designated "Joist Hanger Nail" on package labeling)						
Paper	0.131	Full Round**	n/a	S	X, HDG, EG	100,000
	0.148		n/a	S	X, HDG, EG	90,000
	0.162		n/a	S	X, HDG, EG	90,000
Head markings for metal hardware nails are as follows: '1' for 2½ x 0.131; '8' for 1½ x 0.131; '10' for 1½ x 0.148; '12' for 2½ x 0.148; '16' for 2½ x 0.162						
STAPLES (Brand Names: GRIP-RITE and COMPLETE)						
GAGE		NOMINAL CROWN WIDTH (inch)			FINISH / COATING	
15		7/16			EG	
16		7/16, 1/2, 15/16, 1			X, EG	

SHANGHAI YUEDA NAIL CO., LTD. – SHANGHAI YUEDA (CHINA) & YF TECHNOLOGY CORPORATION (THAILAND) LTD.							
NAILS ¹							
TYPE OF COLLATION	NOMINAL DIAMETER (inch)	HEAD STYLE	MEETS HEAD AREA RATIO REQUIREMENTS FOR USE IN LFRAs	SHANK TYPE	FINISH/ COATING	SPECIFIED BENDING YIELD STRENGTH, F_{yb} (psi)	
Wire	0.092	Full Round	n/a	S, R, Sc	X, EG, HDG, MG	n/a	
	0.099		n/a	S, R, Sc	X, EG, HDG, MG	100,000	
	0.113		Y = 6d	S, R, Sc	X, EG, HDG, MG	100,000	
	0.120		Y 120	S, R, Sc	X, EG, HDG, MG	100,000	
	0.131		Y = 8d	S, R, Sc	X, EG, HDG, MG	100,000	
Plastic Strip	0.113		Y = 6d	S, R, Sc	X, EG, HDG, MG	100,000	
	0.120		Y 120	S, R, Sc	X, EG, HDG, MG	100,000	
	0.131		Y = 8d	S, R, Sc	X, EG, HDG, MG	100,000	
	0.148		Y =10d	S, R	X, EG, HDG, MG	90,000	
	0.162		Y =16d	S, R	X, EG, HDG, MG	90,000	
Plastic Sheet Coil	0.099		Clipped	n/a	S, R, Sc	X, EG, HDG, MG	100,000
	0.113			N	S, R, Sc	X, EG, HDG, MG	100,000
	0.120			Y 120	S, R, Sc	X, EG, HDG, MG	100,000
	0.135			N	S, R, Sc	X, EG, HDG, MG	100,000
Paper	0.092			Clipped	n/a	S, R, Sc	X, EG, HDG, MG
	0.113	Y =6d			S, R, Sc	X, EG, HDG, MG	100,000
	0.120	Y 120			S, R, Sc	X, EG, HDG, MG	100,000
	0.131	Y = 8d		S, R, Sc	X, EG, HDG, MG	100,000	
	0.113	Offset		Y = 6d	S, R, Sc	X, EG, HDG, MG	100,000
	0.120			Y 120	S, R, Sc	X, EG, HDG, MG	100,000
	0.131			N	S, R, Sc	X, EG, HDG, MG	100,000
Metal Hardware Nails ¹							
Paper	0.131	Full Round		n/a	S, R, Sc	X, EG, HDG, MG	100,000
	0.148			n/a	S	X, EG, HDG, MG	90,000
	0.162			n/a	S, R	X, EG, HDG, MG	90,000
STAPLES ²							
GAGE		NOMINAL CROWN WIDTH (inch)		FINISH/ COATING			
14		$\frac{1}{2}, \frac{9}{16}, 1$		X, EG			
15		$\frac{7}{16}, \frac{1}{2}$		X, EG			
16		$\frac{7}{16}, \frac{1}{2}, \frac{15}{16}, 1, 1\frac{1}{16}$		X, EG			

¹ Nails are manufactured by Shanghai Yueda (China).

² Staples are manufactured by Shanghai Yueda (China) and YF Technology (Thailand).

SPECIALTY FASTENING SYSTEMS, INC. DBA SPECIALTY NAIL CO.						
NAILS (Brand names: SPECIALTY NAIL CO., SPECIALTY FASTENERS)						
TYPE OF COLLATION	NOMINAL DIAMETER (inch)	HEAD STYLE	MEETS HEAD AREA RATIO REQUIREMENTS FOR USE IN LFRAs	SHANK TYPE	FINISH/ COATING	SPECIFIED BENDING YIELD STRENGTH, F_{yb} (psi)
Plastic, Paper	0.092	Full Round	n/a	S, R, Sc	X	n/a
			n/a	S	X, HDG, SS, HT	100,000
			n/a	R	X, HDG, SS	100,000
			n/a	Sc	X, HDG	100,000
	0.113		Y =6d	S	X, HDG, SS, HT	100,000
				R	X, HDG, SS	100,000
				Sc	X, HDG	100,000
			Y 120	S	X, HDG, SS, HT	100,000
				R	X, HDG, SS	100,000
				Sc	X, HDG	100,000
	0.131		Y =8d	S	X, HDG, SS, HT	100,000
				R	X, HDG, SS	100,000
				Sc	X, HDG	100,000
	0.148		Y =10d	S	X, HDG, SS, HT	90,000
				R	X, HDG, SS	90,000
	0.162		Y =16d	Sc	X, HDG, HT	90,000

STANLEY BLACK AND DECKER INC.						
NAILS (Brand name: BOSTITCH, DEWALT, CRAFTSMAN)						
TYPE OF COLLATION	NOMINAL DIAMETER (inch)	HEAD STYLE	MEETS HEAD AREA RATIO REQUIREMENTS FOR USE IN LFRAs	SHANK TYPE	FINISH/ COATING	SPECIFIED BENDING YIELD STRENGTH, F_{yb} (psi)
Wire, Plastic	0.092	Full Round	n/a	S, R	X, HDG	n/a
				Sc	X	
	0.099		n/a	S, R, Sc	X, HDG, MG, P1(B) ¹	100,000
			0.113	Y =6d	S, R	X, HDG, EG, MG, P1
	Sc			X, HDG, P1(B) ¹		
	0.120		Y 120	S, R	X, HDG, EG, P1	100,000
				Sc	X, HDG, P1(B) ¹	
	0.131		Y =8d	S	X, HDG, EG, MG, P1	100,000
				R	X, HDG, EG, MG	
Sc		X, HDG, P1(B) ¹				
0.135	Y 135	S	X	100,000		
0.148	Y =10d	S, Sc	X	90,000		
0.162	N	S	X, P1(B) ¹	90,000		
Paper	0.113	Clipped	Y =6d	S	X, HDG, EG, MG, P1	100,000
				R	X, HDG, EG, P1	
				Sc	X, HDG, P1	
	0.120		Y 120	S, R	X, HDG, EG, P1	100,000
				Sc	X, HDG, P1	
	0.131		Y =8d	S, R	X, HDG, EG, P1	100,000
Sc		X, HDG, P1				
Wire, Paper	0.113	Offset	Y =6d N ²	S	X, HDG, EG, P1	100,000
				R	X, HDG, EG, MG, P1	
				Sc	X, HDG, P1	
	0.120		Y 120 N ²	S, R	X, HDG, EG, MG, P1	100,000
				Sc	X, HDG, P1	
	0.131		Y =8d	S	X, HDG, EG, MG, P1	100,000
R		X, HDG, EG, P1				
Sc		X, HDG, P1				
Wire	0.113	Notched	Y =6d	S, R	X, HDG, EG, P1	100,000
				Sc	X, HDG, P1	
	0.120		Y 120	S, R	X, HDG, EG, P1	100,000
				Sc	X, HDG, P1	
	0.131		Y =8d	S, R	X, HDG, EG, P1	100,000
				Sc	X, HDG, P1	
Metal Hardware Nails Designated as "Metal Connector Nail" on package labeling						
Paper, Plastic	0.131	Full Round	n/a	S	X, HDG, EG, MG, P1, HT	100,000
	0.148		n/a	S	X, HDG, EG, MG, P1, HT	90,000
	0.162		n/a	S	X, P1, HT	90,000
When used, head markings for metal hardware nails are as follows: 'B1' for 1½ x 0.131; 'B2' for 2½ x 0.131; 'B3' for 1½ x 0.148; 'B4' for 2½ x 0.148; 'B5' for 2½ x 0.162						
STAPLES (Brand name: BOSTITCH, DEWALT)						
GAGE		NOMINAL CROWN WIDTH (inch)		FINISH/COATING		
15		7/16, 1/2		X		
16		7/16, 1/2, 1		X, EG		

¹P1(B) means that the P1 coating is only available under the BOSTITCH Brand Name.

²Nails that are made in Poland do not meet HAR requirements for use in LFRAs.

DIVISION: 06 00 00—WOOD, PLASTICS AND COMPOSITES
Section: 06 05 23.13—Nails
Section: 06 05 23.15—Staples

REPORT HOLDER:

INTERNATIONAL STAPLE, NAIL AND TOOL ASSOCIATION (ISANTA)

EVALUATION SUBJECT:

POWER-DRIVEN STAPLES AND NAILS

1.0 REPORT PURPOSE AND SCOPE

Purpose:

The purpose of this evaluation report supplement is to indicate that the Power-Driven Staples and Nails described in ICC-ES evaluation report [ESR-1539](#), have also been evaluated for compliance with the codes noted below as adopted by the Los Angeles Department of Building and Safety (LADBS).

Applicable code editions:

- 2023 *City of Los Angeles Building Code* (LABC)
- 2023 *City of Los Angeles Residential Code* (LARC)

2.0 CONCLUSIONS

The Power-Driven Staples and Nails, described in Sections 2.0 through 7.0 of the evaluation report [ESR-1539](#), comply with the LABC Chapter 23, and the LARC, and are subject to the conditions of use described in this supplement.

3.0 CONDITIONS OF USE

The Power-Driven Staples and Nails described in this evaluation report supplement must comply with all of the following conditions:

- All applicable sections in the evaluation report [ESR-1539](#).
- The design, installation, conditions of use and identification of the nails and staples are in accordance with the 2021 *International Building Code*® (IBC) provisions noted in the evaluation report [ESR-1539](#).
- The design, installation and inspection are in accordance with additional requirements of LABC Chapters 16, 17 and 23, and LARC Sections R502, R503, R602, R802 and R803, as applicable.
- In accordance with LABC Section 2304.10.2, staples connecting wood members, must not be used to resist or transfer seismic forces in structures assigned to Seismic Design Category D, E or F.
- In accordance with LABC Sections 2306.2 and 2306.3, engineered diaphragms and shear walls constructed with staples as described in Section 4.1.2 of the evaluation report [ESR-1539](#) are permitted only for structures assigned to Seismic Design Category A, B or C.
- Nails and staples made from bright steel wire must not be used in exterior or exposed conditions.

This supplement expires concurrently with the evaluation report, reissued July 2022 and revised April 2024.

DIVISION: 06 00 00—WOOD, PLASTICS AND COMPOSITES

Section: 06 05 23.13—Nails

Section: 06 05 23.15—Staples

REPORT HOLDER:

INTERNATIONAL STAPLE, NAIL AND TOOL ASSOCIATION (ISANTA)

EVALUATION SUBJECT:

POWER-DRIVEN STAPLES AND NAILS

1.0 REPORT PURPOSE AND SCOPE

Purpose:

The purpose of this evaluation report supplement is to indicate that the power-driven staples and nails described in ICC-ES evaluation report ESR-1539 have also been evaluated for compliance with the codes noted below.

Applicable code editions:

- 2022 *California Building Code* (CBC)

For evaluation of applicable Chapters adopted by the California Office of Statewide Health Planning and Development (OSHPD) AKA: California Department of Health Care Access and Information (HCAI) and the Division of State Architect (DSA), see Sections 2.1.1 and 2.1.2 below.

- 2022 *California Residential Code* (CRC)

2.0 CONCLUSIONS

2.1 CBC:

The power-driven staples and nails, described in Sections 2.0 through 7.0 of the evaluation report ESR-1539, comply with CBC Chapter 23, provided the design and installation are in accordance with the 2021 *International Building Code*® (IBC) provisions noted in the evaluation report and the additional requirements of CBC Chapters 16, 17 and 23, as applicable.

2.1.1 OSHPD: The applicable OSHPD Sections and Chapters of the CBC are beyond the scope of this supplement.

2.1.2 DSA: The applicable DSA Sections and Chapters of the CBC are beyond the scope of this supplement.

2.2 CRC:

The power-driven staples and nails, described in Sections 2.0 through 7.0 of the evaluation report ESR-1539, comply with CRC Chapters 5, 6, 7 and 8, provided the design and installation are in accordance with the 2018 *International Residential Code*® (IRC) provisions noted in the evaluation report.

This supplement expires concurrently with the evaluation report, reissued July 2022 and revised April 2024.

DIVISION: 06 00 00—WOOD, PLASTICS AND COMPOSITES**Section: 06 05 23.13—Nails****Section: 06 05 23.15—Staples****REPORT HOLDER:****INTERNATIONAL STAPLE, NAIL AND TOOL ASSOCIATION (ISANTA)****EVALUATION SUBJECT:****POWER-DRIVEN STAPLES AND NAILS****1.0 REPORT PURPOSE AND SCOPE****Purpose:**

The purpose of this evaluation report supplement is to indicate that Power-Driven Staples and Nails described in ICC-ES evaluation report ESR-1539, have also been evaluated for compliance with the codes noted below.

Applicable code editions:

- 2023 and 2020 *Florida Building Code—Building*
- 2023 and 2020 *Florida Building Code—Residential*

2.0 CONCLUSIONS

The Power-Driven Staples and Nails, described in Sections 2.0 through 7.0 and Appendix B of ICC-ES evaluation report ESR-1539, comply with the *Florida Building Code—Building* and the *Florida Building Code—Residential*. The design requirements must be determined in accordance with the *Florida Building Code—Building* or the *Florida Building Code—Residential*, as applicable. The installation requirements noted in ICC-ES evaluation report ESR-1539 for the 2021 and 2018 *International Building Code*® (IBC) meet the requirements of the *Florida Building Code—Building* or the *Florida Building Code—Residential*, as applicable.

Use of the Power-Driven Staples and Nails has also been found to be in compliance with the High-Velocity Hurricane Zone provisions of the *Florida Building Code—Building* and the *Florida Building Code—Residential*.

For products falling under Florida Rule 61G20-3, verification that the report holder's quality assurance program is audited by a quality assurance entity approved by the Florida Building Commission for the type of inspections being conducted is the responsibility of an approved validation entity (or the code official, when the report holder does not possess an approval by the Commission).

This supplement expires concurrently with the evaluation report, reissued July 2022 and revised April 2024.